

AGE[®]



INDEX

ELECTRIC PISTON PUMP AIRLESS SPRAYER	EC021, PM021, PM021LF, PM025, PM031, PM039	
AIR-ASSISTED AIRLESS PAINT SPRAYER	AC023	5~11
HVLP TURBINE PAINT SPRAYER	T328	
<hr/>		
MAGNETIC CORE DRILL		
Semi Auto Feed Magnetic Drilling Machine	MD300N	
Low Profile Magnetic Drilling Machine	PMD3530	
Auto-Reverse Tapping & Core Drill Machine	TP2000	
Single Speed Magnetic Drilling Machine	SMD351L, SMD351H	
2 Speed Magnetic Drilling Machine	SMD352, SMD502	
2 Speed Swivel Base Magnetic Drilling Machine	ST50	12~26
2 Speed Magnetic Drilling Machine	MD500/2	
4 Speed Magnetic Drilling Machine	MD750/4	
4 Speed Swivel Base Magnetic Drilling Machine	MDS750/4	
4 Speed Magnetic Drilling Machine	MD120/4	
Vacuum Base Adapter		
Magnetic Drilling Machines Optional Accessory Specifications		
<hr/>		
METAL WORKING TOOLS		
Tapper	T14	
Die Grinder & Long Neck Angle Grinder	DG50, DG50N, DG50L, DG50LN & DG152, DG152N	
Slimline Angle Grinders	A100, B100	
Angle Grinder	AG9	
Straight Grinder	SG6	
Wraparound Tube Sander / Polisher	WS760, WS620	
Drum Sander / Polisher	DP100	27~46
Electric Shear	ST301	
Sheet Metal Nibbler	LY16	
High Frequency Beveling System	HP1400, P3000	
Electric Beveler	EB6, EB6T, EB12, EB24, EB24R	
8" Metal Cutting Circular Saw	CS200	
9" Metal Cutting Circular Saw	CS230N	
Metal Cutting Circular Saw	CS320	
Dry Cut Saw	DRC355	
<hr/>		
PLUMBING INDUSTRIAL TOOLS		
Digital Bending Machine	DB32	
Manual Pipe Threader Sets		
Portable Threading Machine	PT600	46~55
Drain Cleaning Machine	D65	
Hole Cutting Drill	HC127	
Press Fitting Machine	PF8	
Reciprocating Saw	RS26, RS130B	
<hr/>		
WET/DRY VACUUM DUST EXTRACTOR	DE25, DEP25	
WOOD WORKING TOOLS		
Plunge-Cut Circular Saw	DS2300, DS1600	56~62
Miter Saw	GP255, GP255S	
TCT Saw Blades		
<hr/>		
STONE & CONCRETE WORKING TOOLS		
Stone Grinder	EP5W, EP5WN, EP5L, EP5LN, EP5LF, EP5LFN, EP5LFB, EP5LFBN, EP7F, EP7FB	
Wall Chaser	CS125, CS125N, CS150, CS150N, CS180,	
Stone Cutting Circular Saw	SCS7	
Concrete Saw	C14, C16	
Wet Tile Saw	TS9	
High Frequency Integrated Concrete Vibrator	H42S, H42, H50S, H50	63~82
High Frequency Concrete Vibrator System	V42, V52, P1000	
Concrete Vibrator	VR600, VRN1400	
Rotary Bush hammer	BH92	
Long-Reach Diamond Grinder	LG125	
Concrete Grinder	SM5, SM7	
Scouring Machine	SM125	
<hr/>		
ELECTRIC DRYWALL SANDER	HS225, GS9FSE, GS9FE	
ROTARY POLISHER	SP2500, SP4000, RP160, RP220	
ELECTRIC MIXER		83~93
Electric Mixer	EV32, EV42, EV52, EV160	
Electric Mixer	EV10ELM	
Electric Mixer / Drill	EVP180, EV21	
Bucket Mixer	AM5000, AM5000NC	
<hr/>		
DIAMOND CORE DRILL		
Vacuum Pump	VP140	
Tile Core Drill	TC20, TC40, TC402	
Tile Core Drill Machine	TC100	
Diamond Core Drilling Machines	LY120, LY150	
Wet + Dry Diamond Core Drill	DM160	
Wet+Dry Diamond Core Drill	DM51P, DM51D, DM52P, DM52D	95~109
Wet+Dry Diamond Core Drill	DMC6P, DMC6D	
Diamond Core Drilling Machine	DM6P, DM6D	
Rig-Mounted Diamond Core Drill Motors	DM10, DM14	
Diamond Core Drill Stands	S170, S250, S500, S800, OS250	
Diamond Core Bits & Optional Accessory Specifications		
<hr/>		
ELECTRIC SCREW DRIVER	LY0855	
WOOD TRIMMER	LY0608N	
FLEXIBLE SHAFT GRINDER	LY128	111
IMPACT WRENCH	LY1726	
GEAR MACHINING & ELECTRONICS BOARDS		



The professional's choice..... **AGP**[®]

Lee Yeong Industrial Co., Ltd. was established in the year 1988 and with our brand, **AGP**, has become a leader in the professional power tools industry. The high performance and durability of our machines in the field speaks for itself. The reliability and strength of our tools is the result of our engineering to the smallest detail. Metallurgical precision of key components such as gears and bearings results in machines of unequaled dependability.

But the heart of **AGP** machines are their motors. Lee Yeong is first and foremost an electric motor manufacturer. In addition to all motor production, we are equipped with full design and development facilities. This allows us to custom tailor all of our machines' motors to ensure optimum performance in their specific application. This is something that no off-the-shelf outside sourced motors could ever do.

We combine our motor expertise with our other strong point: machine design and engineering. Some of our inventions and designs have garnered prestigious awards and international patents. We use the latest in 3-D computer aided design to quickly and efficiently go from a design, to a prototype, to actual tooling. Many clients make good use of this capability to have our tools custom designed to fit their specific needs.

Our philosophy has always been to strive for a balance between bold innovation and constant improvement. Between fluid adaptability and extreme concentration to detail. We are constantly searching for ways to improve and welcome new challenges.



Variable Speed



Double Insulation



Speed Stabilization



Forward and Reverse Switch



Blow Molded Case



Two Speed



Plastic Carry Case



Overload Protection



Three Speed



Steel Case



Soft Start



Four Speed

★ Manufacturer reserves the right to update specifications without prior notice. Specifications herein are for reference only. For latest specifications, refer to the machine nameplate.

ELECTRIC PISTON PUMP AIRLESS SPRAYER

The **EC021** is a triumph of simplicity and reliability with its mechanical pressure control system. It also very light for easy transport and movement around the job site. The high efficiency air-cooled DC motor is powerful enough to run a 0.021 tip. This airless sprayer can handle a very wide range of paint types. It can spray among others:

- Wood interior: lacquer, varnish, stain, sealer, enamel,
- Ceiling: high-build,
- Wood exterior: exterior stain, vinyl, acrylic, latex,
- Masonry: alkyd, vinyl, latex,
- Structural steel: heavy coating

The Optional **6.2L Hopper Kit** allows you to use small amounts of paint media at a time and makes it much easier to clean and switch between colors. The smooth interior surface of the hopper is much quicker to wipe clean. For small amounts of material and frequent color changes, the hopper is the perfect choice. The special drain tube and all necessary hardware are included in the kit.



Model	EC021
Motor Type	DC Motor, Fan-Cooled
Power input	700W
Voltage	110-120V~ 50-60Hz , 220-240V~ 50-60Hz
Max Tip Size	0.021 in.
Max Flow	1.9 l/min (0.50 gpm)
Max Pressure	207 bar (3,000 psi)
Dimensions (LxWxH)	360mm x 250mm x 400mm
Net Weight	11.0kg (24.25Lbs)

- STANDARD ACCESSORIES**
- * Tommy Bar x1
 - * Flexible Suction Hose x 1
 - * Throat Seal Oil (100ml Squeeze Bottle) x1

- OPTIONAL ACCESSORIES**
- * Pump Filter Set x1
 - * Replacement Pump Filter Screen x1
 - * Hose 1/4" X 25' (7.5M) x1
 - * Hose 1/4" X 54' (16.5M) x1
 - * Gun - (Not incl. Tip Guard or Tip) x1
 - * 6.2L Hopper Kit x1
 - * Pressure Gauge x1

■ ACCESSORIES

	Reversible Tip, with Seat	Size	Part number	Size	Part number
		513 (0.013")	305-00168-000-001	525 (0.025")	305-00168-000-008
		215 (0.015")	305-00168-000-019	529 (0.029")	305-00168-000-012
		315 (0.015")	305-00168-000-020	531 (0.031")	305-00168-000-009
		515 (0.015")	305-00168-000-002	533 (0.033")	305-00168-000-010
		517 (0.017")	305-00168-000-003	535 (0.035")	305-00168-000-006
		519 (0.019")	305-00168-000-004	537 (0.037")	305-00168-000-013
		521 (0.021")	305-00168-000-005	539 (0.039")	305-00168-000-014
		523 (0.023")	305-00168-000-007		

ELECTRIC PISTON PUMP AIRLESS SPRAYER

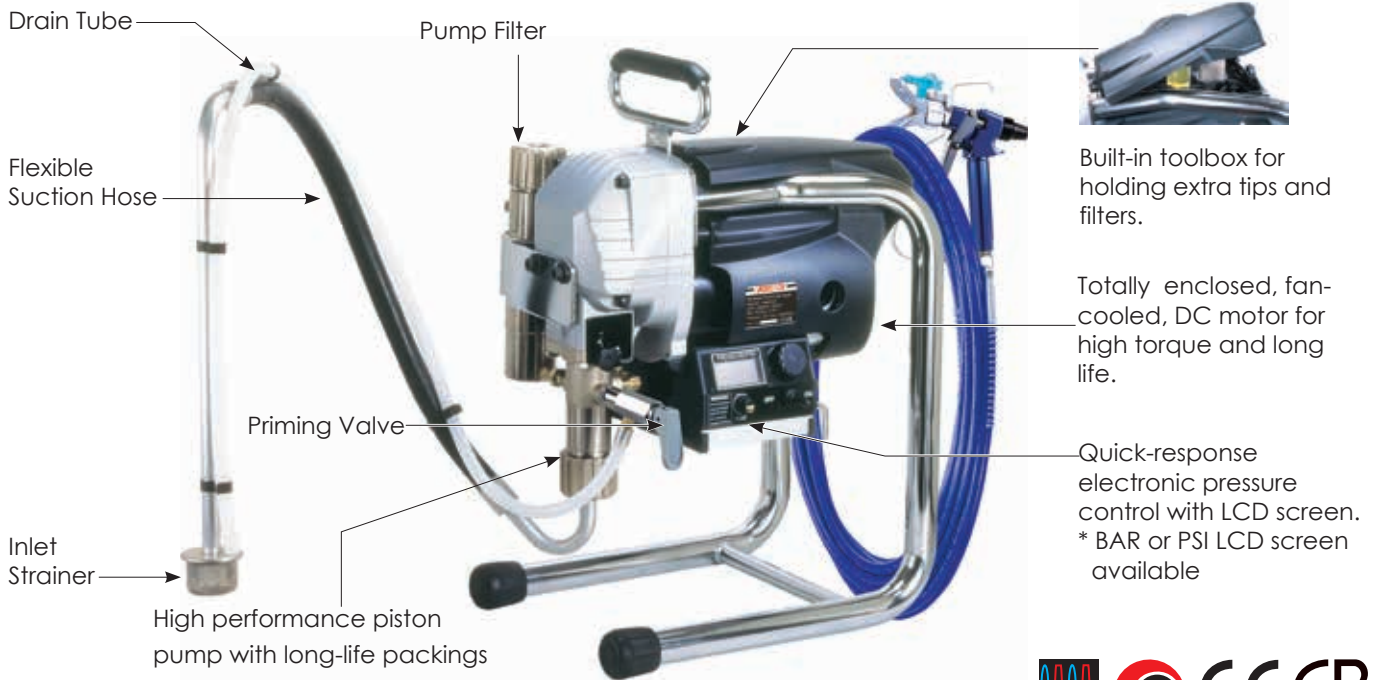

Model	PM021LF
Motor Type	DC Motor (TEFC)
Power Input	1000W
Voltage	110-120V~ 50-60Hz, 220-240V~ 50-60Hz
Max. Tip Size	0.021in.
Max. Flow	2.1 l/min (0.55 gpm)
Max. Pressure	207 bar (3,000 psi)
Control	Digital
Overload Protection	With
Dimensions(LxWxH)	420mm x 300mm x 550mm
Net Weight	23.4kg (51.56 Lbs)

STANDARD ACCESSORIES

- * Hose 1/4" x 54' (16.5M) x1
- * Gun With Tip Guard and Tip (0.017 In.) x1
- * Pump Filter W/ One Each 60 & 100 Screens x1
- * Special Multi-Purpose Wrench x1
- * Flexible Suction Hose x1
- * Throat Seal Oil (100ml Squeeze Bottle) x1
- * Tommy Bar x1

OPTIONAL ACCESSORY

- * Pump Filter W/ 30 screen x1

ACCESSORIES

	Part Number		Part Number
	0299-0074-00000-001		302-03009-000-001
High Pressure Hose 3/8" x 15.5 m + 1/4" x 1.5m Whip Hose for PM039, PM031			0299-0072-00000-005
High Pressure Hose 1/4" x 16.5 m for PM021, PM025, PM021LF, EC021	303-02012-099-001		0299-0072-00000-006
	0201-0096-00906-001		0299-0049-00000-001
Tip Extensions 11/16" x 15"(L)	0201-0096-00906-001		0299-0049-00000-007
Tip Extensions 11/16" x 30"(L)	0201-0096-00906-003		0299-0050-00000-001
Tip Extensions 11/16" x 60"(L)	0201-0096-00906-005		0299-0050-00000-002
Tip Extensions 7/8" x 15"(L)	0201-0096-00906-002		
Tip Extensions 7/8" x 30"(L)	0201-0096-00906-004		0299-0061-00000-001
Tip Extensions 7/8" x 60"(L)	0201-0096-00906-006		0299-0061-00000-002
	0299-0060-00000-001		
	202-0007-00000-001		
Pump Filter- 60 Mesh	202-0007-00000-002		
Pump Filter-100 Mesh	202-0007-00000-003		

ELECTRIC PISTON PUMP AIRLESS SPRAYER

Our airless sprayers **PM021 & PM025, PM021LF** can handle a very wide range of paint types. They can use among others:

- **Wood interior:** lacquer, varnish, stain, sealer, enamel,
- **Ceiling:** high-build,
- **Wood exterior:** exterior stain, vinyl, acrylic, latex,
- **Masonry:** alkyd, vinyl, latex, elastomeric, block filler,
- **Structural steel:** heavy coating.



Model	PM021	PM025
Motor Type	DC Motor (TEFC)	DC Motor (TEFC)
Power Input	1000W	1300W
Voltage	110-120V~ 50-60Hz, 220-240V~ 50-60Hz	
Max. Tip Size	0.021in.	0.025in.
Max. Flow	2.1 l/min (0.55 gpm)	2.7 l/min (0.71 gpm)
Max. Pressure	207 bar (3,000 psi)	207 bar (3,000 psi)
Control	Digital	
Overload Protection	With	
Dimensions (LxWxH)	515mm x 530 x 795mm	515mm x 530 x 795mm
Net Weight	29.5kg (65.04 Lbs)	29.6kg (65.26 Lbs)

- STANDARD ACCESSORIES**
- * Hose 1/4" X 54' (16.5M) x1
 - * Gun With Tip Guard and Tip (0.017 In.) x1
 - * Pump Filter W/ One Each 60 & 100 Screens x1
 - * Special Multi-Purpose Wrench x1
 - * Rigid Suction Tubex1
 - * Throat Seal Oil (100ml Squeeze Bottle) x1
 - * Tommy Bar x1
- OPTIONAL ACCESSORIES**
- * Flexible Suction Hose x1
 - * Pump Filter W/ 30 screen x1



AIR-ASSISTED AIRLESS PAINT SPRAYER

Our **AC023** self-contained air-assisted airless sprayer can be used with or without air assist. It is suitable for spraying a wide range of sealers, topcoats, primers, wiping stains, lacquers and enamels. Air-assisted airless combines the hydraulic atomization of airless with the atomization of air spray to provide a finer finish and break up the tailing effect at the edge of the spray pattern while limiting overspray and "bounce back". This results in higher transfer efficiency than either straight airless, air spray or HVLP. Ideal for many fine finishing and coating applications, air assist offers high production levels and a very smooth finish -perfect for wood furniture topcoats, fabricated metal parts and other fine finish applications.



1/4" Bonded Air & Fluid Hose 7.5M
1/4" Bonded Air & Fluid Hose 12M

Part Number
305-00291-000-002
305-00291-000-001



Model	AC023
Motor Type	DC Motor (TEFC)
Power Input	1300W
Voltage	110-120V~ 50-60Hz, 220-240V~ 50-60Hz
Max. Tip Size	0.023 in.
Max. Fluid Flow	2.1 l/min (0.55 gpm)
Max. Pressure	207 bar (3,000 psi)
Atomizing Air Output	100 l/min (3.5 cfm)
Max. Working Air Pressure	2.4 bar (35psi)
Control	Digital
Dimensions(LxWxH)	856mm x 592mm x 1015mm
Net Weight	55.6kg(122.58lbs) (including Hopper assembly not including hose)

STANDARD ACCESSORIES

- *1/4" Bonded Air & Fluid Hose 7.5M (L) x1
- * Hopper Assembly (6.2 liter) x1
- * Special Multi-purpose Wrench x1
- * Pump Filter W/ One Each 60 and 100 Screens x1
- * Throat Seal Oil (100ml Squeeze Bottle) x1
- * Tommy Bar x1

OPTIONAL ACCESSORIES

- * 1/4" Bonded Air & Fluid Hose 12M (L) x1
- * Pump Filter W/ 30 screen x1

ELECTRIC PISTON PUMP AIRLESS SPRAYER

Our airless sprayers **PM031** can handle a very wide range of paint types. The powerful piston pump is able to spray and hydraulically atomize almost any thickness material as long as it does not contain solid particles such as sand, stones, etc.

- **Wood interior:** lacquer, varnish, stain, sealer, enamel.
- **Ceiling:** high-build, drywall mud.
- **Wood exterior:** exterior stain, vinyl, acrylic, latex, alkyd.
- **Drywall:** vinyl, latex, plaster, skim coat and drywall mud.
Easily spray Hand texture effects such as orange peel, knockdown and splatter.
- **Masonry:** elasomeric, block filler, alkyd.
- **Structural steel:** heavy coating.



Model	PM031
Motor Type	Brushless DC Motor
Power Input	1500W
Voltage	110-120V~ 50-60Hz, 220-240V~ 50-60Hz
Max. Tip Size	0.031in.
Max. Flow	4.17 l/min (1.1 gpm)
Max. Pressure	227 bar (3,300 psi)
Control	Digital
Overload Protection	With
Dimensions(LxWxH)	670mm x 580mm x810mm
Net Weight	59.0kg (130.07 Lbs)

STANDARD ACCESSORIES

- * Hose 3/8" x 50' (15.5M) + Whip Hose 1/4" x1.5M x1
- * Gun With Tip Guard and Tip (0.31 In.) x1
- * Inlet strainer 20 Mesh x1
- * Pump Filter W/ One Each 60 & 100 Screens x1
- * Special Multi-Purpose Wrench x1
- * Throat Seal Oil (100ml Squeeze Bottle) x1
- * Tommy Bar x1

OPTIONAL ACCESSORY

- * Pump Filter W/ 30 screen x1

ELECTRIC PISTON PUMP AIRLESS SPRAYER

Our **PM039** airless sprayers are designed specifically for professional painting contractors. The state of the art electronic pressure control system allows ideal atomization under all conditions. The long-duty piston pump and direct gear drive are built for the long haul. The fully enclosed brushless motors are built for ample power and heavy duty cycles all day long. There is sufficient power to run two guns if desired. The quick-change pump filter is easy to access and clean. All aspects of the machines were carefully designed for convenience and speed of maintenance and cleaning. This all adds up to the excellent results which professionals demand.

The **PM039** can handle a very wide range of paint types, These are our most powerful sprayers and they can be even be used as texture sprayers. The powerful piston pump is able to spray and hydraulically atomize almost any thickness material as long as it does not contain solid particles such as sand, stones, etc. The PM039 is specially equipped for plaster, skim coat and texture materials: It comes standard with a special plaster type suction assembly with low-mounted spring assisted check ball for easy priming. It also has a ball-type priming valve for increased flow.

- **Wood interior:** lacquer, varnish, stain, sealer, enamel.
- **Ceiling:** high-build, drywall mud.
- **Wood exterior:** exterior stain, vinyl, acrylic, latex, alkyd.
- **Drywall:** vinyl, latex, plaster, skim coat and drywall mud.
Easily spray Hand texture effects such as orange peel, knockdown and splatter.
- **Masonry:** elasomeric, block filler, alkyd.
- **Structural steel:** heavy coating.



Built-in Toolbox for holding extra tips and filters.

Ball Type Priming Valve

Powerful Brushless Motor

High performance piston pump with long-life packings

Special Plaster-Type Suction Assembly for plaster and other heavy materials

Special hooks for coupling with plaster tank

Inlet Strainer

Drain Tube



Coupling Adapter



Plaster Tank (Optional for PM039) The frames of both units interlock with special hooks for a neat and compact assembly. Includes special coupling adapter, wringer and scraper plate.



Quick-response electronic pressure control with LCD screen.

* BAR or PSI display selectable



STANDARD ACCESSORIES

- * Hose 3/8" x 50' (15.5M) + Whip Hose 1/4" x1.5M x1
- * Gun With Tip Guard and Tip (0.035in.) x1
- * Inlet strainer 20 Mesh x1
- * Pump Filter W/ One Each 60 & 100 Screens x1
- * Special Multi-Purpose Wrench x1
- * Throat Seal Oil (100ml Squeeze Bottle) x1
- * Tommy Bar x1

OPTIONAL ACCESSORIES

- * Plaster Tank Set (95 Liter) x1
- * Pump Filter W / 30 screen x1

Model	PM039
Motor Type	Brushless Motor
Power Input	1800W
Voltage	110-120V~ 50-60Hz, 220-240V~ 50-60Hz
Max. Tip Size	0.039in.
Max. Flow	6.4 l/min (1.7 gpm)
Max. Pressure	227 bar (3,300 psi)
Control	Digital
Overload Protection	With
Dimensions(LxWxH)	670mm x 580mm x 810mm
Net Weight	61.1kg (134.7 Lbs)

HVLP TURBINE PAINT SPRAYER

The **T-328 HVLP turbine** uses an industrial grade 3-stage turbine powered by a 1400W motor to meet the performance needs of professional painters. The variable airflow goes to a maximum of 2800 L/min and pressure of 0.41 bar for doing big jobs quickly. Our purpose-built non-bleeder type gun gives excellent atomization for controlled results. We also thought about convenience. The top has a compartment for carrying extra tips and needles. The air filter is easy to access. The carry handle is at the perfect balance point and all hose connections are quick release.



		Part Number
HVLP Gun Set	1.3mm	305-00172-000-001
	1.8mm	305-00172-000-002
	2.0mm	305-00172-000-003
Air Hose 6M		0299-0109-00000-002
Radiator Kit		0299-0107-00000-001
250ml Plastic Cup		305-00299-000-001



		Part Number
Needle Nozzle Set	0.5mm	305-00167-000-001
	0.8mm	305-00167-000-002
	1.0mm	305-00167-000-003
	1.2mm	305-00167-000-004
	1.3mm	305-00167-000-005
	1.8mm	305-00167-000-006
	2.0mm	305-00167-000-007
	2.5mm	305-00167-000-008



Model	T328
Voltage	110-120V~ 50-60Hz, 220-240V~ 50-60Hz
Power Input	1400W
Turbine	3 Stage
Airflow	2800 l/min
Max. Working Pressure	0.41 bar (6 psi)
Soft Start	With
Turbine Dimensions (LxWxH)	325mm x 250mm x 325mm
Net Weight	8.9kg (19.62Lbs)

STANDARD ACCESSORIES

- * Air Hose 6M x1
- * Gun with 1.3mm x1
- Needle Nozzle Set x1

OPTIONAL ACCESSORIES

- * Needle Nozzle Sets x1
- * Radiator Kit x1
- * 250ml Plastic Cup for Gun x1

SEMI AUTO FEED MAGNETIC DRILLING MACHINE

The **MD300N** is an incredible time saving machine. It feeds forward automatically with special circuitry to adjust the feed rate to the ideal speed for the most efficient possible drilling. It still has full manual capability.

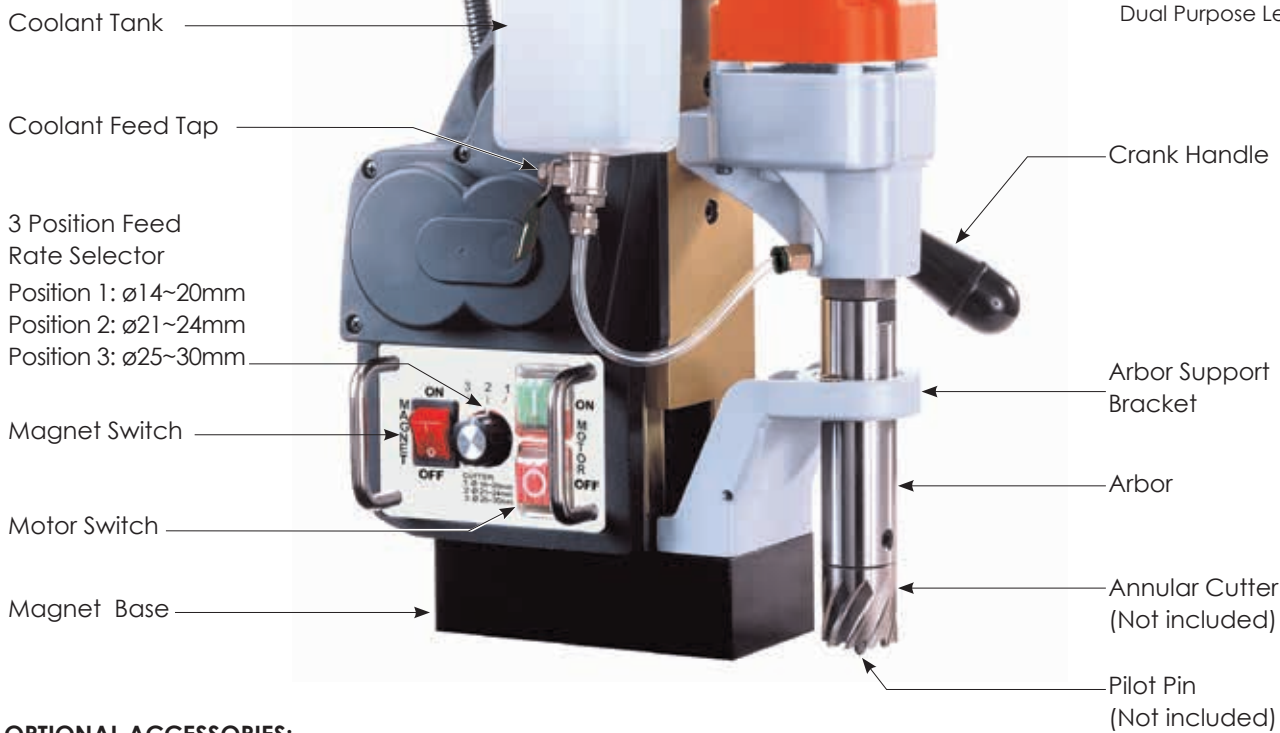
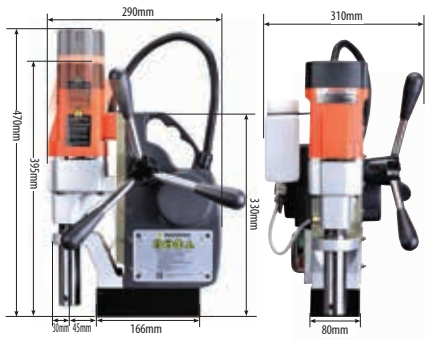

OPTIONAL ACCESSORIES:

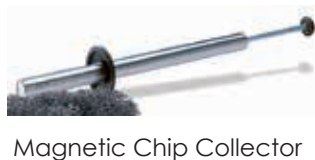

Model	MD300N	
Power Input	1100W	
Voltage	110-120V~ 50-60Hz, 220-240V~ 50-60Hz	
No / Full Load min ⁻¹	550 / 330	
Max. Capacity	Dia. X Depth of Cut (Hand Feed)	35 mm x 50 mm (1-3/8" x 2")
	Dia. X Depth of Cut (Auto Feed)	30 mm x 45mm (1-3/16" x 1-3/4")
	Dia. X Depth of Twist Drill Bit (Hand Feed Only)	13mm x 115mm (1/2" x 4-1/2")
	Dia. X Depth of Taps	N/A
Magnetic Adhesion	15,000 N	
Overload Protection	With	
Net Weight	16kg (35.27 Lbs)	

STANDARD ACCESSORIES

- * Wrench M8 x1
- * Hex. Key M2.5 x1
- * Hex. Key M4 x1
- * Chip Guard Kit x1
- * Coolant Tank Kit x1
- * Safety Chain x1

LOW PROFILE MAGNETIC DRILLING MACHINE

Our incredible new low clearance mag drill can enter spaces impossible to reach with a conventional mag drill. Although the total height is only 198mm without the handle, conventional 35mm length cutters can be used. No need for special cutters.

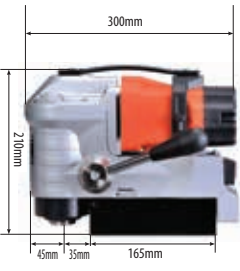

Good balance for Carrying



The quick adjustable tool-free lever can mounted on either side.



Quick release arbor for fast cutter changes.

Annular Cutter (Not included)

Pilot Pin (Not included)



LED light for work in dark spaces

Motor Switch

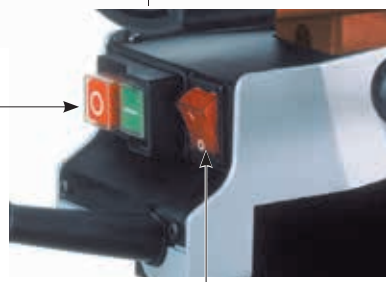

Magnet Switch



Model	PMD3530
Power Input	1100W
Voltage	110-120V~ 50-60Hz, 220-240V~ 50-60Hz
No / Full Load min ⁻¹	650 / 390
Max. Capacity Dia. X Depth of Cut	35mm x 35mm
Weldon Shank	19.05mm (3/4")
Magnetic Adhesion	15,000 N
Net Weight	10.5kg (23.15 Lbs)

STANDARD ACCESSORIES

- * Safety Belt x1
- * Chip Guard Kit x1

OPTIONAL ACCESSORIES

- * Overload Protection

AUTO-REVERSE TAPPING & CORE DRILLING MACHINE PATENTED

This is a purpose-built tapping machine which can also work perfectly well as a conventional mag drill. It is equipped with a two-mode gear box: one mode for mechanical auto-reverse tapping and one mode for annular cutters and twist drills. The quick-release spindle allows fast, tool-free changing of accessories. Since the quick-release spindle is 31mm Bilz no.2, a huge variety of accessories are readily available from us or from outside which will directly fit in this machine's spindle. A reducing sleeve may be used to also use 19mm Bilz no.1 accessories. It is a **patented** design and when tapping, the operator has very fine control of the forward, stop and reverse motion by the crank handle.

The system gives unparalleled responsiveness and feel for quick, efficient and trouble-free tapping operations. Our all new Universal Tap Chuck grips squares from 4.9mm up to 12mm, so any tap from any system, be it DIN, ISO, JIS, or ANSI will work. We limit the minimum size to M6 (1/4") and can go up to M20 (3/4") all in one chuck.

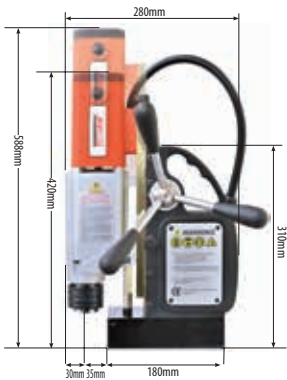

Annular Cutter Arbor
(Annular cutter and pilot pin not included)

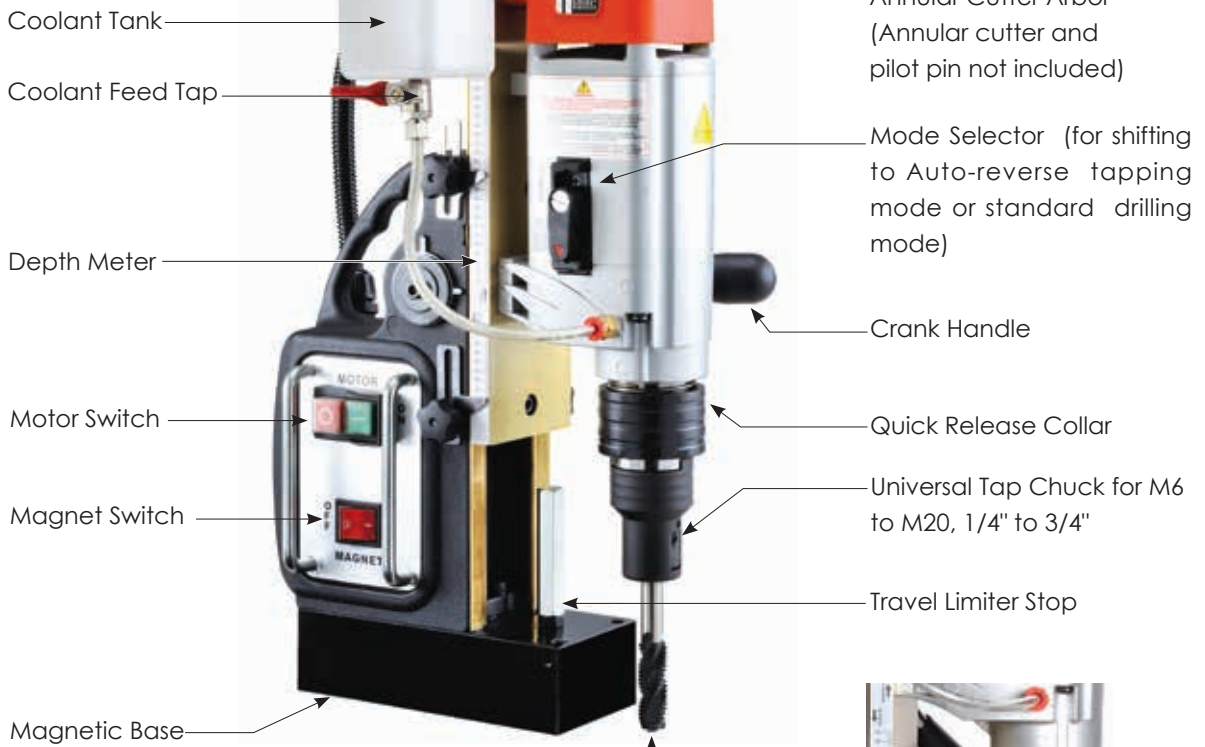

Depth Meter

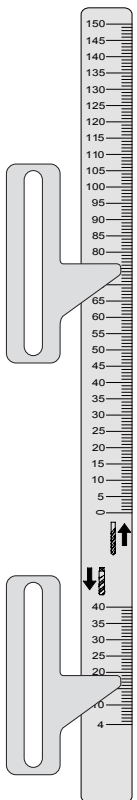

Mode Selector

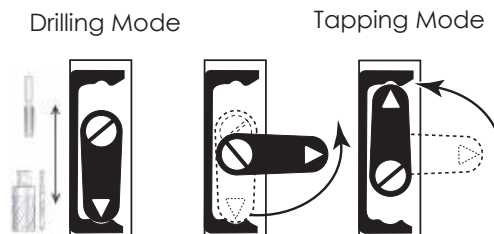

Drill Chuck Arbor (Twist drill not included)

Mode Selector

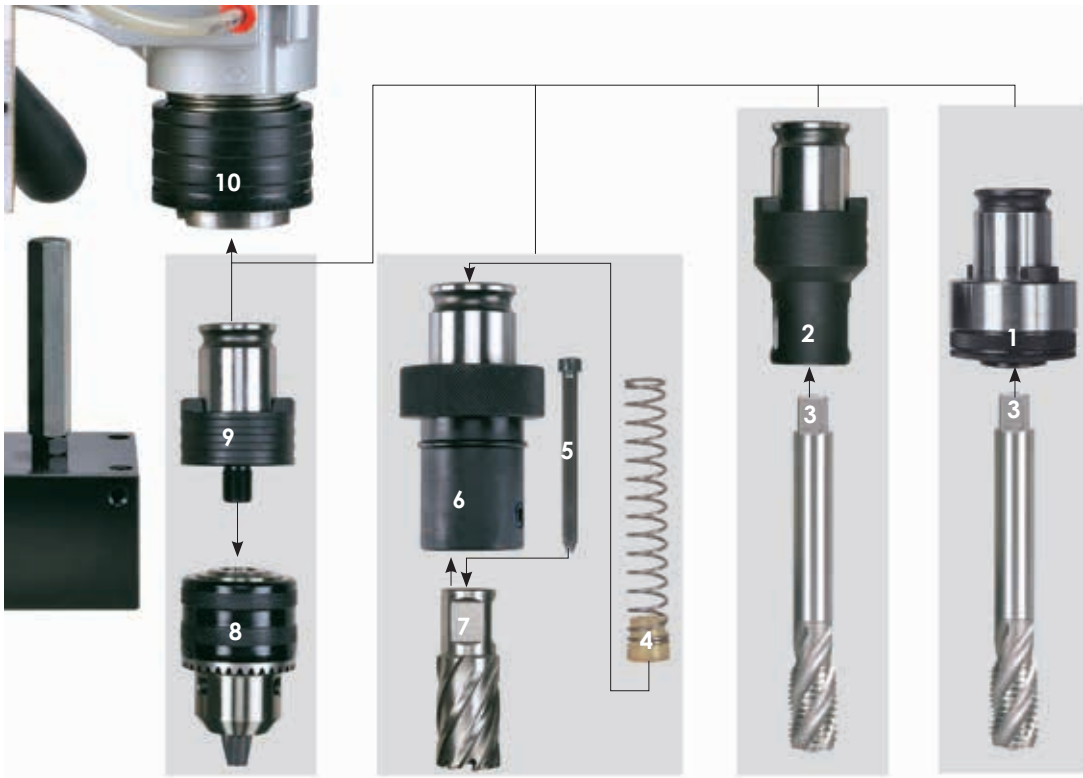

- | | |
|--|--|
| 1. Large Range Clamp Collet (Not Included) | 6. Annular Cutter Arbor 3/4" (19.05mm)Weldon Shank) |
| 2. Universal Tap Chuck | 7. Annular Cutter (Not included) |
| 3. Tap (Not included) | 8. 1/2" Twist Drill Chuck |
| 4. Coolant Feed Spring And Seal | 9. Drill Chuck Arbor |
| 5. Pilot Pin (Not included) | 10. Quick-Release Collar |

OPTIONAL ACCESSORIES:



Annular Cutter



Pilot Pin



Magnetic Chip Collector



Large Range Bilz
no.2 Clamp Collets
(see p.24)

(Patented)

Model	TP2000
Power Input	1100W
Voltage	110-120V~ 50-60Hz, 220-240V~ 50-60Hz
Drilling Mode No / Full Load min ⁻¹	550 / 330
Tapping Mode No / Full Load min ⁻¹	150 / 90
Spindle Coupling	31mm (Bilz no.2)
Annular Cutter Arbor	Set Screw Type, 19.05mm (3/4") Weldon Shank
Annular Cutters	35mm x 50mm (1-3/8" x 2")
Taps	20mm x 40mm (13/16" x 1-9/16")
Twist Drills	13mm x 135mm (1/2" x 5-5/16")
Magnetic Adhesion	15,000 N
Net Weight	14.5kg(31.97Lbs)



STANDARD ACCESSORIES

- * Universal Tap Chuck x1
- * Wrench M8 x1
- * 2.5mm L-Hex Key x1
- * 4mm L-Hex Key x1
- * Drill Chuck Arbor x1
- * 1/2" Chuck And Chuck Key x1
- * Annular Cutter Arbor x1
- * 3/4" (19.05mm)Weldon Shank x1
- * Coolant Tank Kit x1
- * Chip Guard Kit x1
- * Safety Chain x1

OPTIONAL ACCESSORIES

- * Other sizes of Clamp Collets

SINGLE SPEED MAGNETIC DRILLING MACHINE

Available in either high or low speed versions, this is our workhorse model. It drills in the size range most commonly required and is rugged and reliable.

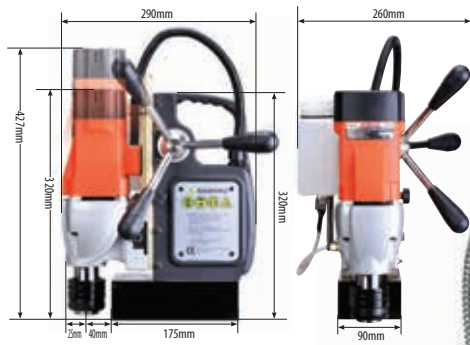

The quick-adjustable variable height slide allows a variety of tools to be used. Lower for cutters, raise for twist drills.

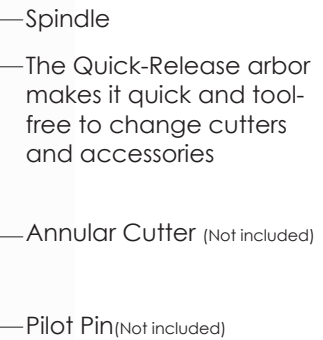

OPTIONAL ACCESSORIES:

TWIST DRILLING



A revolution in time savings, the new special weldon shank drill chuck mounts directly into the quick release arbor. This means it now takes just seconds to convert from cutters to twist drills!



Quick Release Chuck Adaptor And 13mm Chuck & Chuck Key



Annular Cutter



Pilot Pin



Magnetic Chip Collector



Model	SMD351L	SMD351H
Power Input	1100W	
Voltage	110-120V~ 50-60Hz, 220-240V~ 50-60Hz	
No / Full Load min ⁻¹	450 / 270	730 / 440
Max. Capacity	Dia. X Depth of Cut	35mm x 50mm (1-3/8" x 2")
	Dia. X Depth Twist Drill Bit	13mm x 140mm (1/2" x 5-1/2")
Magnetic Adhesion	17,000 N	
Net Weight	16kg (30.86 Lbs)	

STANDARD ACCESSORIES

- * Wrench M8 x1
- * Hex. Key M2.5 x1
- * Hex. Key M4 x1
- * T- Wrench M6 x1
- * Coolant Tank Kit x1
- * Safety Chain x1
- * Chip Guard Kit x1

OPTIONAL ACCESSORIES

- * Overload Protection

2 SPEED MAGNETIC DRILLING MACHINE

Our two speed models give added versatility for maximum torque using a wide range of cutters

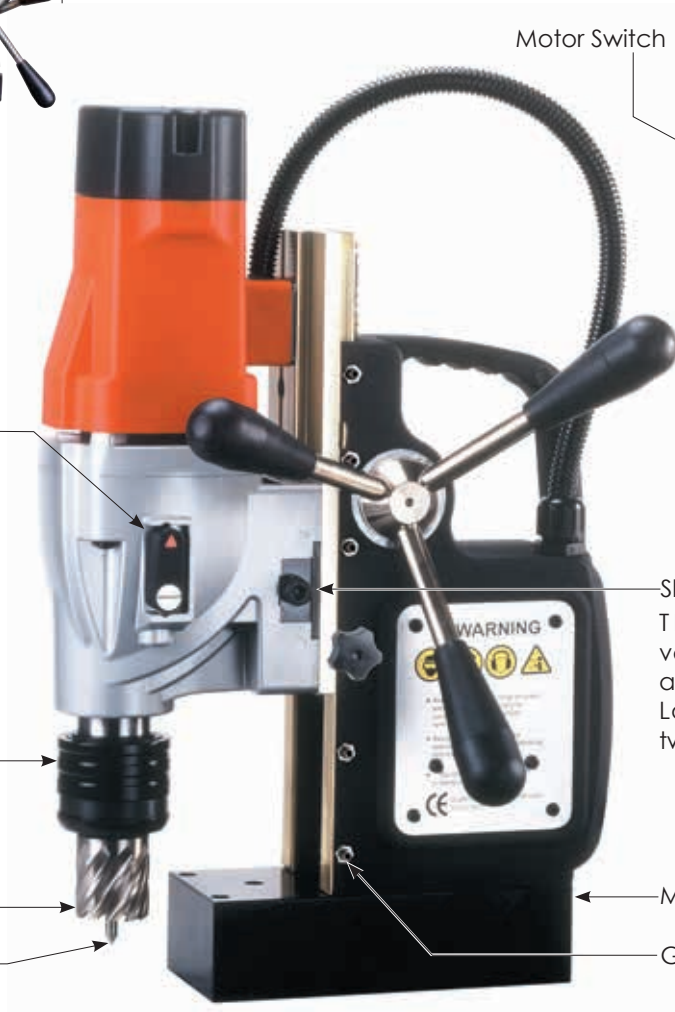
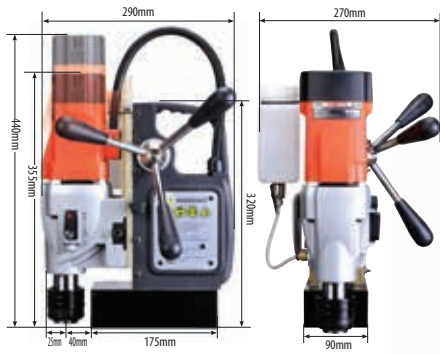

The 2-Speed Gear Box allows a wide range of cutters to be used and delivers maximum torque

The Quick-Release Arbor makes it quick and tool-free to change cutters and accessories

Annular Cutter (Not included)

Pilot Pin (Not included)

Slide Height Lock
The quick-adjustable variable height slide allows a variety of tools to be used. Lower for cutters, raise for twist drills. (See SMD351L)

TWIST DRILLING



A revolution in time savings, the new special weldon shank drill chuck mounts directly into the quick release arbor. This means it now takes just seconds to convert from cutters to twist drills!

OPTIONAL ACCESSORIES:



Quick Release Chuck Adaptor And 13mm Chuck & Chuck Key

Annular Cutter Pilot pin

Magnetic Chip Collector



Model	SMD352		SMD502
Power Input	1100W		
Voltage	110-120V~ 50-60Hz, 220-240V~ 50-60Hz		
No / Full Load min ⁻¹	Speed 1	450 / 270	300 / 180
	Speed 2	730 / 440	450 / 270
Max. Capacity	Dia. X Depth of Cut	35mm x 50mm (1-3/8" x 2")	50mm x 50mm (2" x 2")
	Dia. X Depth Twist Drill Bit	13mm x 140mm (1/2" x 5-1/2")	
Magnetic Adhesion	17,000 N		
Net Weight	16kg (33.07 Lbs)		

STANDARD ACCESSORIES

- * Wrench M8 x1
- * Hex. Key M2.5 x1
- * Hex. Key M4 x1
- * T- wrench M6 x1
- * Coolant Tank kit x1
- * Safety Chain x1
- * Chip Guard Kit x1
- * Overload Protection(SMD502)

OPTIONAL ACCESSORIES

- * Overload Protection(SMD352)

2 SPEED SWIVEL BASE MAGNETIC DRILLING MACHINE

The **ST50** is a highly versatile magnetic drill which is packed with useful features. These give the machine a huge range of capabilities - all in one tool! The MT2 (Morse Taper no.2) spindle allows a wide range of cutting tools and attachments to be directly mounted. These include, among others, annular cutter arbors, drill chucks, tapping attachments, MT2 shank tools such as twist drills, reamers and countersinks - and more. It comes standard with a 1/2" drill chuck as well as a unique universal tapping chuck, which can steplessly grip taps from M6 up to M20. The spindle has a fixed coolant feed ring which supplies cutting fluid to applicable attachments. The two speed gear box allows maximum torque for varied applications. The motor is reversible and has stepless variable speed. The smart electronics also feature soft start and overload protection. The swivel base allows the machine to mount in difficult positions with limited space: It can swivel 30 degrees (15 degrees to each side) and move 15mm back and forth. Truly a full-function mag drill system!

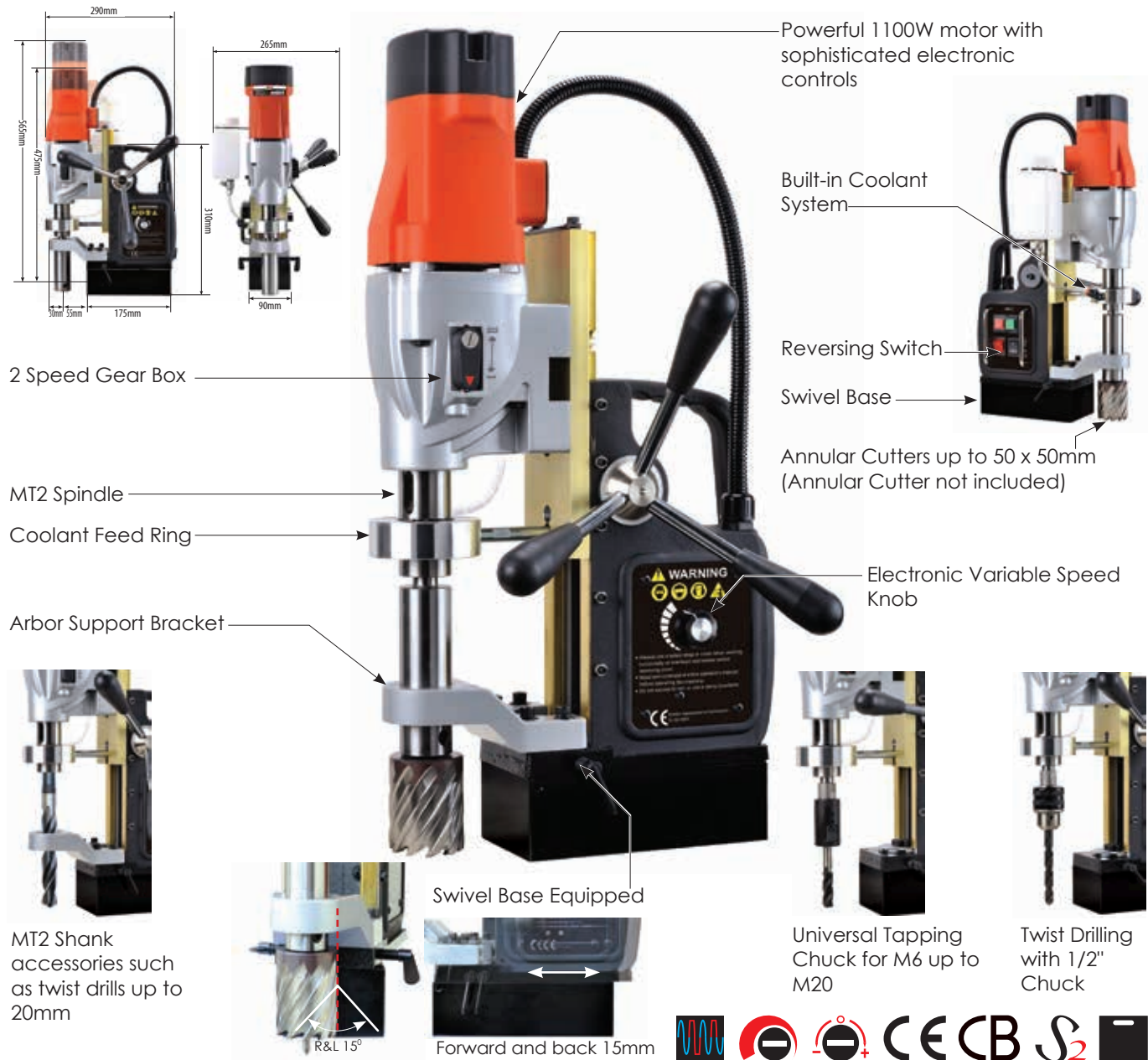

MODEL	ST50	
Power Input	1100W	
Voltage	110-120V~ 50-60Hz, 220-240~ 50-60Hz	
No / (Full) Load min ⁻¹	Speed 1	150~300 (90~180)
	Speed 2	225~450 (135~270)
Max. Capacity	Dia. x Depth of Cutter	50mm x 50mm (2" x 2")
	Dia. x Depth of MT2 Drill	20mm x 150mm (13/16" x 5-7/8")
	Dia x Depth of Chuck Drill	20mm x 110mm (13/16" x 4-5/16")
	Dia x Depth of Tap	M20 x 40mm (13/16" x 1-9/16")
Magnetic Adhesion	17,000 N	
Overload Protection & Soft Start	With	
Net Weight	16.4kg (36.16 Lbs)	

- STANDARD ACCESSORIES**
- * Annular Cutter Arbor x1
 - * Drift x1
 - * Wrench M8x1 x1
 - * Hex Key M2.5 x1
 - * Hex Key M4 x1
 - * Hex Key M5 x1
 - * Coolant Tank Kit x1
 - * Chip Guard Kit x1
 - * Safety Chain x1
 - * Chuck Adaptor x1
 - * Tapping Adapter x1
- OPTIONAL ACCESSORIES**
- * 1/2" (13mm) Chuck, Key x1

2 SPEED MAGNETIC DRILLING MACHINE

This heavy duty machine has extra magnet force and the capability of running extra long 75mm cutters.

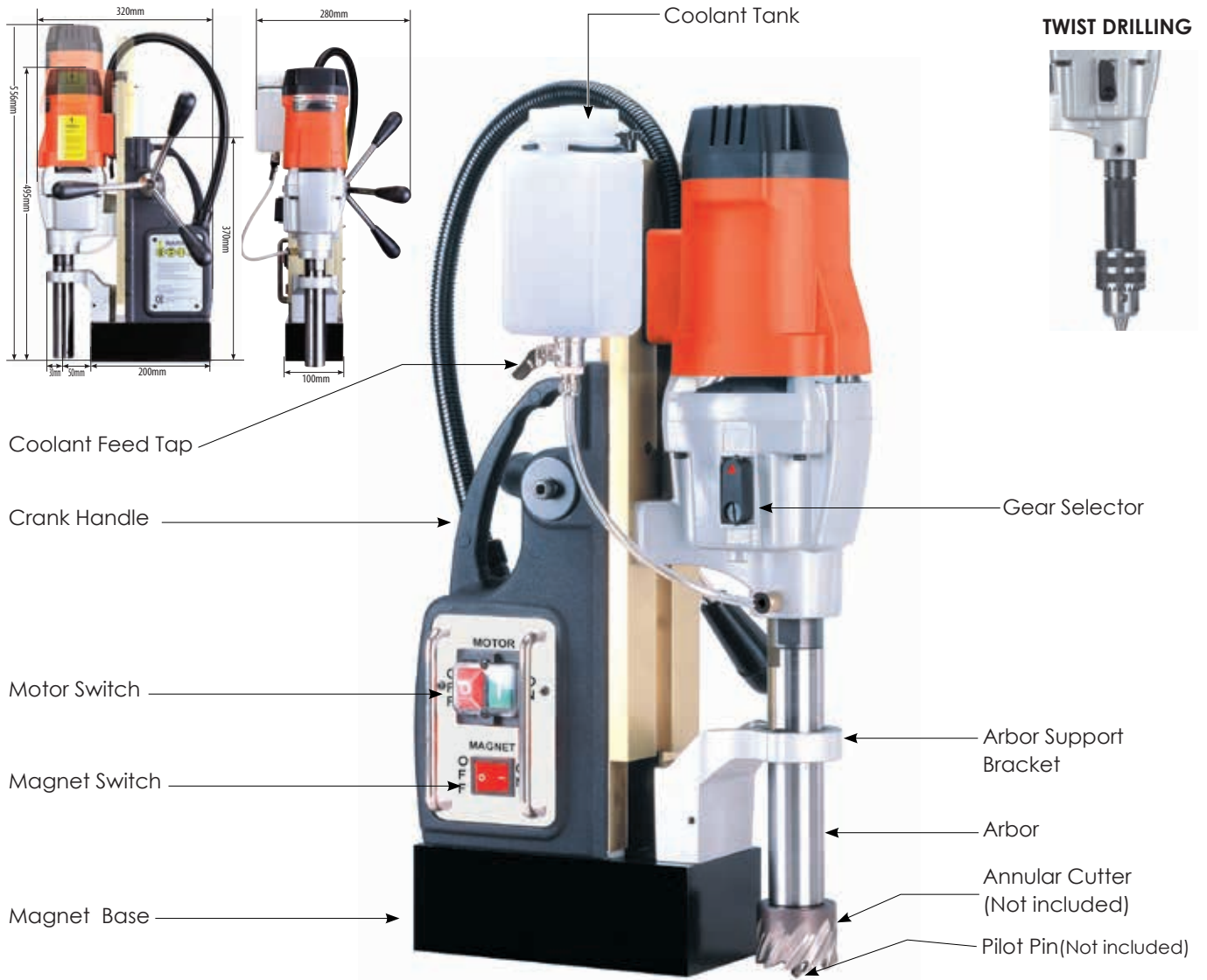

OPTIONAL ACCESSORIES:



Model		MD500/2
Power Input		110-120V:1700W, 220-240V:2000W
Voltage		110-120V~ 50-60Hz, 220-240V~ 50-60Hz
No / Full Load min ⁻¹	Speed 1	380 / 230
	Speed 2	500 / 300
Max. Capacity	Dia. X Depth of Cut	50 mm x 75 mm (2" x 3")
	Dia. X Depth of Twist Drill Bit	16mm x 115mm (5/8" x 4-1/2")
	Dia. X Depth of Taps	N/A
Magnetic Adhesion		32,000 N
Overload Protection		With
Net Weight		21.1kg (46.52 Lbs)

STANDARD ACCESSORIES

- * Wrench M8 x1
- * Hex. Key M2.5 x1
- * Hex. Key M4 x1
- * Chip Guard Kit x1
- * Coolant Tank Kit x1
- * Safety Chain x1

OPTIONAL ACCESSORIES

- * Chuck Adaptor x1
- * 5/8" (16mm) Chuck & Chuck Key x1

4 SPEED MAGNETIC DRILLING MACHINE

Four mechanical speeds with reversing switch for a large range of capabilities. Unique MT3 spindle with cutting fluid feed

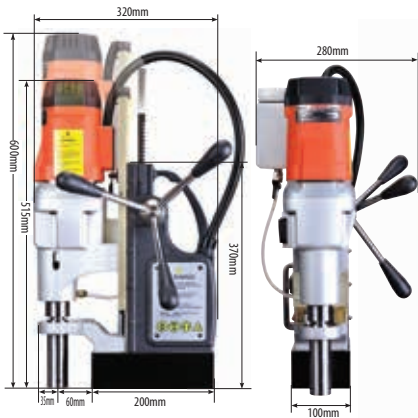

Twist Drilling with Chuck



MT3 Chuck Adaptor and Chuck (Not included)

Twist Drilling



MT3 Twist Drill Bit (Not included)

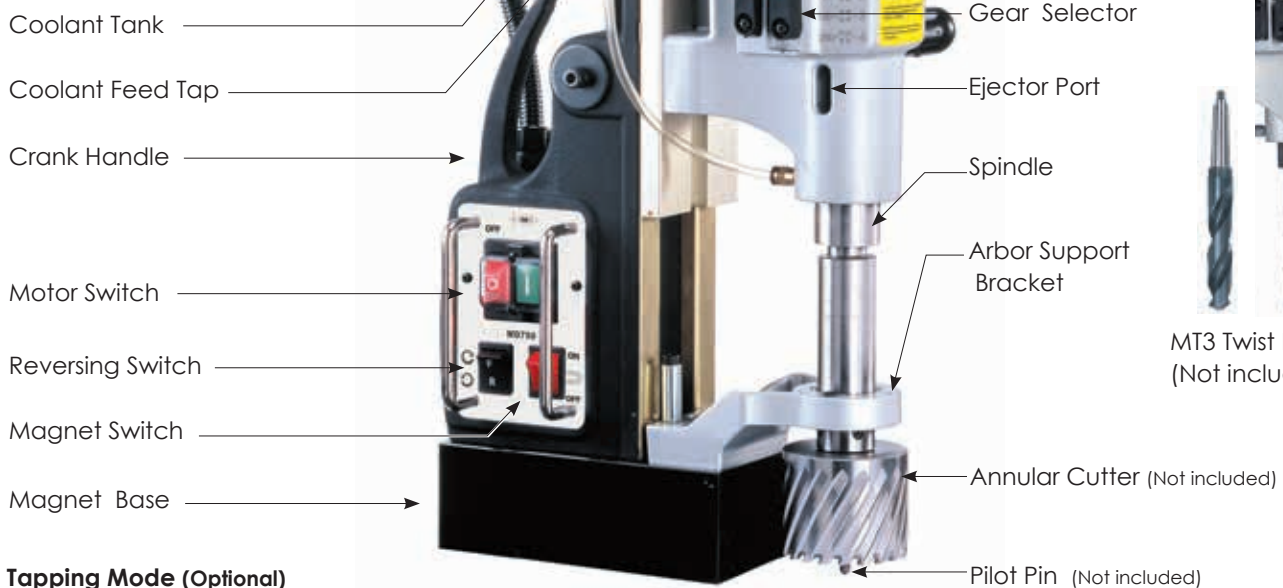

Tapping Mode (Optional)



MT3 Large Range Tapping Chuck & Clamp Collet
MT3 Small Range Tapping Chuck & Clamp Collet

OPTIONAL ACCESSORIES:



Annular Cutter Pilot Pin Magnetic Chip Collector



Model	MD750/4	
Power Input	110-120V:1700W, 220-240V:2000W	
Voltage	110-120V~ 50-60Hz, 220-240V~ 50-60Hz	
No/Full Load min ⁻¹	Speed 1	150 / 90
	Speed 2	200 / 120
	Speed 3	300 / 180
	Speed 4	380 / 230
Max. Capacity	Dia. X Depth of Cut	75 mm x 50 mm (3" x 2")
	Dia. X Depth of MT3 Twist Drill Bit	32 mm x 150 mm (1-1/4" x 4-7/8")
	Dia. X Depth of MT3 Chuck Adaptor With Twist Drill Bit	16mm x 110mm (5/8" x 4-1/2")
	Dia. X Depth of Taps	25.4 mm x 40 mm (1" x 1-9/16")
Magnetic Adhesion	32,000 N	
Overload Protection	With	
Net Weight	24.8kg (64.67 Lbs)	

STANDARD ACCESSORIES

- * Wrench M8 x1
- * Hex. Key M2.5 x1
- * Hex. Key M4 x1
- * Chip Guard Kit x1
- * Coolant Tank Kit x1
- * Safety Chain x1
- * Drift x1

OPTIONAL ACCESSORIES

- * MT3 Chuck Adaptor x1
- * 5/8" (16mm) Chuck & Chuck Key x1
- * MT3 Tapping Adaptors x1
- * Tapping Attachments x1
- * Pipe Vise x1
- * Quick-Release Arbor x1

4 SPEED SWIVEL BASE MAGNETIC DRILLING MACHINE

Like the 4 speed machine above but with the additional feature of swivel base capability for drilling in difficult to access areas

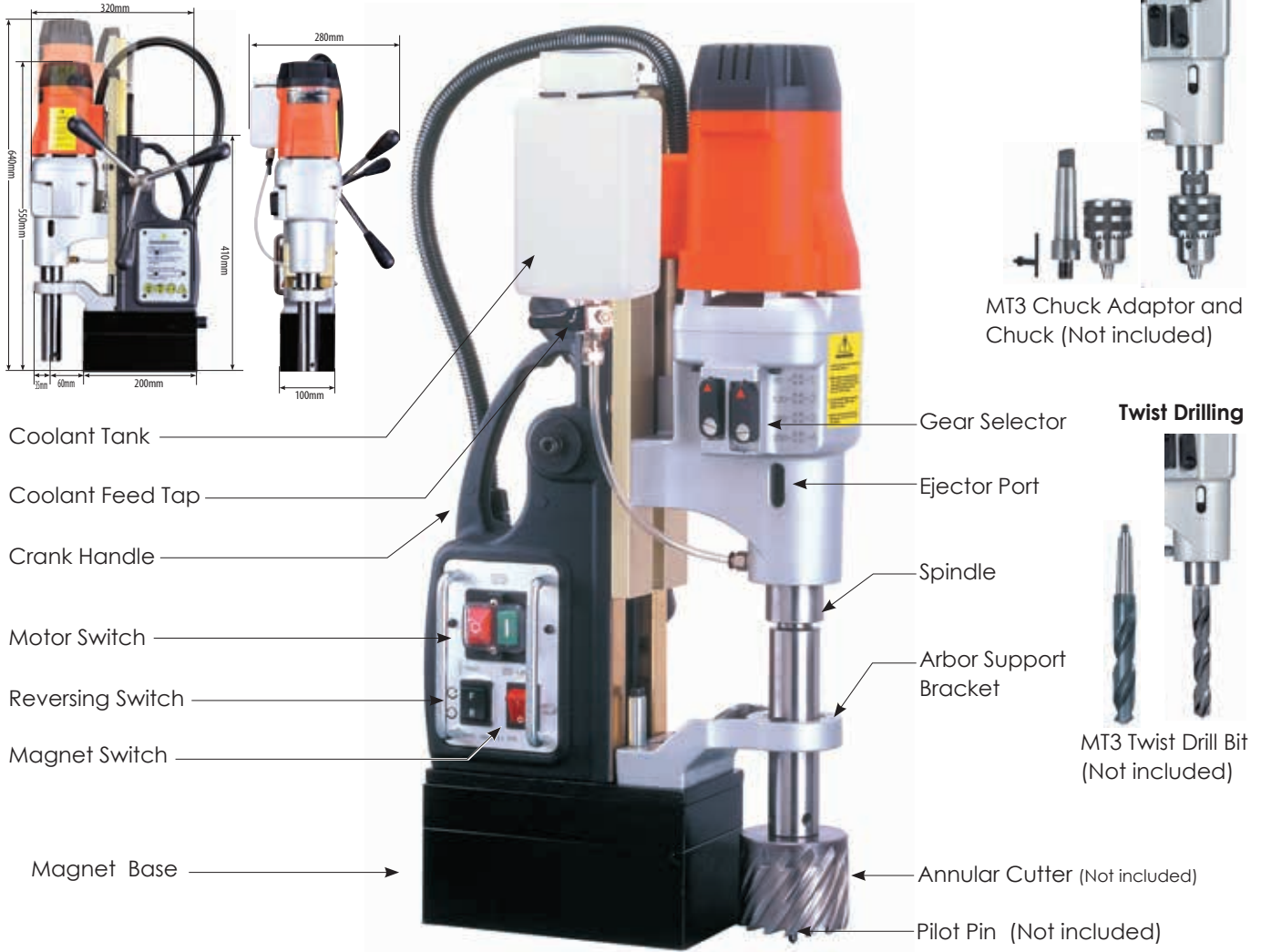

Twist Drilling with Chuck



Twist Drilling



SWIVEL BASE EQUIPPED MODELS

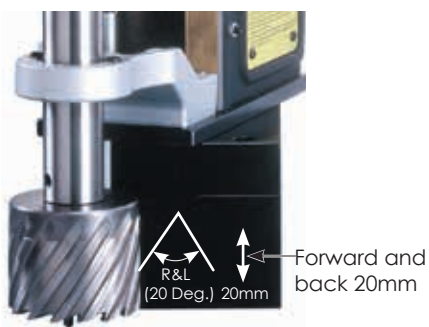

Tapping Mode (Optional)



Model	MDS750/4	
Power Input	110-120V:1700W, 220-240V:2000W	
Voltage	110-120V~ 50-60Hz, 220-240V~ 50-60Hz	
No/Full Load min ⁻¹	Speed 1	150 / 90
	Speed 2	200 / 120
	Speed 3	300 / 180
	Speed 4	380 / 230
Max. Capacity	Dia. X Depth of Cut	75 mm x 50 mm (3" x 2")
	Dia. X Depth of MT3 Twist Drill Bit	32 mm x 150 mm (1-1/4" x 4-7/8")
	Dia. X Depth of MT3 Chuck Adaptor With Twist Drill Bit	16mm x 115mm (5/8" x 4-1/2")
	Dia. X Depth of Taps	25.4 mm x 40 mm (1" x 1-9/16")
Magnetic Adhesion	32,000 N	
Overload Protection	With	
Net Weight	27kg (59.52 Lbs)	

- STANDARD ACCESSORIES**
- * Wrench M8 x1
 - * Hex. Key M2.5 x1
 - * Hex. Key M4 x1
 - * Chip Guard Kit x1
 - * Coolant Tank Kit x1
 - * Safety Chain x1
 - * Drift x1
 - * Wrench M17 x1
- OPTIONAL ACCESSORIES**
- * MT3 Chuck Adaptor x1
 - * 5/8" (16mm) Chuck & Chuck Key x1
 - * MT3 Tapping Adaptors x1
 - * Tapping Attachments x1
 - * Pipe Vise x1
 - * Quick-Release Arbor x1

4 SPEED MAGNETIC DRILLING MACHINE

This is our largest capacity machine yet. It's an amazingly powerful and versatile machine with the very important addition of stepless variable speed with speed stabilization. The feedback circuitry allows maximum power, even when the speed is reduced: Ideal for maximum size cutters. The smart electronics also feature soft start and overload protection. For safety there is an effective mechanical clutch.

Twist Drilling with Chuck

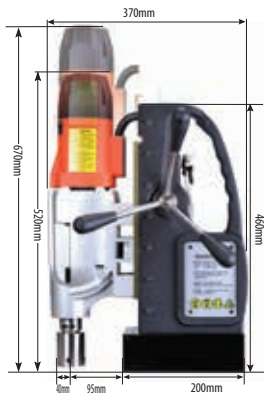

Stepless variable speed wheel

Coolant Tank



MT3 Chuck Adaptor and Chuck (Not included)

Super efficiency 2000W motor with smart electronic controls including soft start, overload and variable speed with speed stabilization.

Rugged four speed Gear Box with mechanical clutch

Gear Selector

Ejector Port

Through-the-spindle cutting fluid system

Special MT3 high-torque tang drive spindle (still mounts any MT3 accessory)

Motor switch

Reversing Switch

Magnet Switch

Twist Drilling



MT3 Twist Drill Bit (Not included)

OPTIONAL ACCESSORIES:



MT3 Large Range Tapping Chuck & Clamp Collet



MT3 Small Range Tapping Chuck & Clamp Collet



Quick Release Arbor



Annular Cutter



Pilot Pin



Magnetic Chip Collector



Model	MD120/4	
Power Input	110-120V: 1700W, 220-240V: 2000W	
Voltage	110-120V~ 50-60Hz, 220-240V~ 50-60Hz	
No Load min ⁻¹	Speed 1	35-120
	Speed 2	70-220
	Speed 3	80-250
	Speed 4	140-450
Max. Capacity	Dia. X Depth of Cut with 31.7mm (1-1/4") Weldon Shank Annular Cutter Arbor	120mm x 50mm
	Dia. X Depth of Cut with 19.05mm (3/4") Weldon Shank Annular Cutter Arbor	120mm x 50mm
	Dia. X Depth of Cut with Quick-Release Arbor	60mm x 50mm
	Dia. X Depth of MT3 Twist Drill Bit	32mm x 200mm
	Dia. X Depth of MT3 Chuck Adaptor with Twist Drill bit	16mm x 120mm
Dia. X Depth of Taps	32mm x 40mm	
Overload Protection	With	
Magnetic Adhesion	32,000 N	
Net Weight	29.4kg(64.82Lbs)	

STANDARD ACCESSORIES

- * Wrench M8x1
- * Hex key M2.5 & M5 x1
- * Chip Guard Kit x1
- * Coolant Tank Kit x1
- * Safety Chain x1
- * Drift x1
- * 31.75 Annular Cutter Set
- * Screw Arbor x1
- * 19.05 Annular Cutter Set
- * Screw Arbor x1

OPTIONAL ACCESSORIES

- * MT3 Chuck Adaptor x1
- * 5/8" (16mm) Chuck & Chuck Key x1
- * MT3 Tapping Adaptors x1
- * Tapping Attachments x1
- * Quick-Release Arbor x1

VACUUM BASE ADAPTER

The Vacuum Base Adapter allows any mag drill to drill up to 55mm holes on surfaces where the magnet's adhesion would not work or would be problematic such as:

- Non-magnetic surfaces such as aluminum, brass, stainless steel, fiberglass, etc.
- Thin steel or even sheet metal where the magnetic force would be insufficient.
- Patterned surfaces with irregularities less than 3mm deep such as diamond plate.

The mag drill attaches magnetically to the vacuum adapter plate and the adapter adheres to the work surface by vacuum force. A vacuum pump must be used which can achieve a minimum of 0.8 bar (26inHg) vacuum and flow of 30 L/min (1 cfm) such as our VP140 Vacuum Pump.

Drilling with cutters larger than 55mm is not recommended with this device.

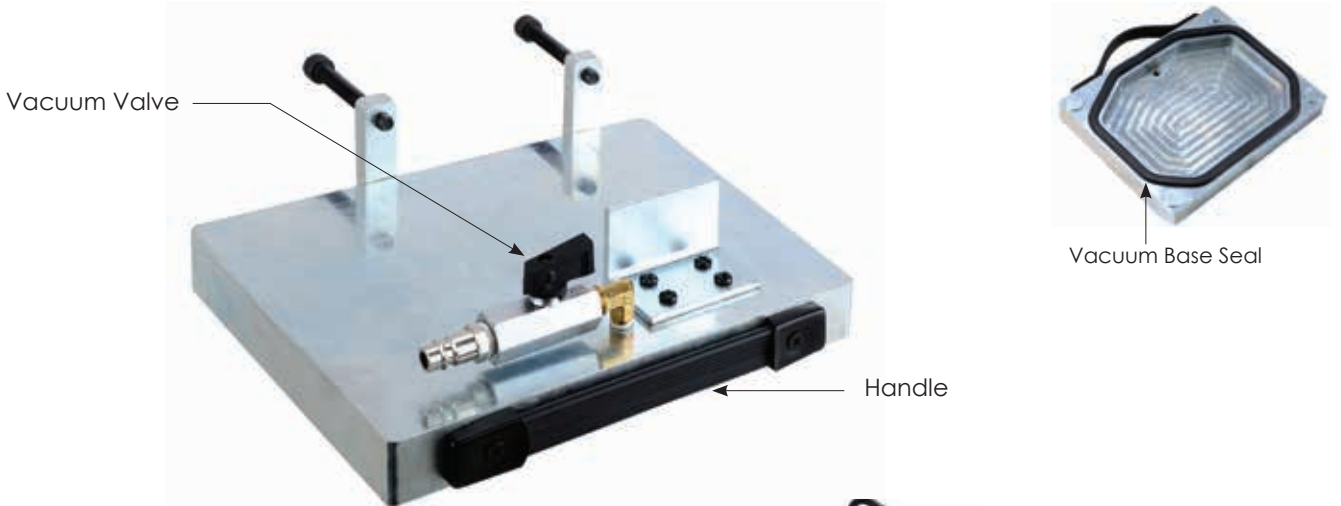

Model	Vacuum Base Adapter
Minimum Required Vacuum	0.8 bar (26 inHg)
Minimum Required Flow Rate	30L/min (1 cfm)
Maximum Annular Cutter	55mm
Dimensions(LxWxH)	234mm x 209mm x 81mm
Net Weight	5.4kg (11.9Lbs)



(For Vacuum Pump, see p.91)

■ Pipe Vise (for use with MDS750/4)

For Pipe Diameters 32mm - 203mm (1-1/4" - 8-1/4")

Part Number 0299-0062-00000-001

■ Pipe Vise (for use with MD750/4)

For Pipe Diameters 32mm - 203mm (1-1/4" - 8-1/4")

Part Number 0299-0062-00000-002



MAGNETIC DRILLING MACHINES OPTIONAL ACCESSORY SPECIFICATIONS

■ MD750/4 , MDS750/4 , MD120/4 Tapping Attachments

■ MT3 Small Range Tapping Chuck & Small Range (Bilz no.1) Clamp Collets (for use with 302-04293-901-001)

Part Number

302-04293-901-001

MT3 Small Range Tapping Chuck (For Clamp Collets 3 ~ 15mm)



Clamp Collets

Part Number	Nominal Tap Sizes:	Shank Dia.:	Size of Square:
305-00155-000-001	M3-JIS	4.0	3.2
305-00155-000-002	M4-JIS	5.0	4.0
305-00155-000-003	M5-JIS	5.5	4.5
305-00155-000-004	M6-JIS	6.0	4.5
305-00155-000-005	M7/M8-JIS	6.2	5.0
305-00155-000-006	M9/M10-JIS	7.0	5.5
305-00155-000-007	M11-JIS	8.0	6.0
305-00155-000-008	M12-JIS	8.5	6.5
305-00155-000-009	M14/M15-JIS	10.5	8.0
305-00155-000-040	UNC5/16-JIS	6.1	5.0
305-00155-000-041	UNC1/2-JIS	9.0	7.0

Clamp Collets

Part Number	Nominal Tap Sizes:	Shank Dia.:	Size of Square:
305-00155-000-015	M3.5-DIN376	2.5	2.1
305-00155-000-016	M4-DIN376	2.8	2.1
305-00155-000-017	M4.5 / M5 -DIN376	3.5	2.7
305-00155-000-019	M6-DIN376	4.5	3.4
305-00155-000-020	M7-DIN376	5.5	4.3
305-00155-000-021	M8-DIN376	6.0	4.9
305-00155-000-022	M10-DIN376	7.0	5.5
305-00155-000-023	M12-DIN376	9.0	7.0
305-00155-000-024	M14-DIN376	11.0	9.0

■ MT3 Large Range Tapping Chuck & Large Range (Bilz no.2) Clamp Collets (for use with 302-04293-901-002) and with TP2000

Part Number

302-04293-901-002

MT3 Large Range Tapping Chuck (For Clamp Collets 7 ~ 25mm)



Clamp Collets

Part Number	Nominal Tap Sizes:	Shank Dia.:	Size of Square:
305-00155-000-030	M7/M8-JIS	6.2	5.0
305-00155-000-031	M9/M10-JIS	7.0	5.5
305-00155-000-032	M11-JIS	8.0	6.0
305-00155-000-033	M12-JIS	8.5	6.5
305-00155-000-034	M14/M15-JIS	10.5	8.0
305-00155-000-010	M16-JIS	12.5	10.0
305-00155-000-011	M18-JIS	14.0	11.0
305-00155-000-012	M20-JIS	15.0	12.0
305-00155-000-013	M22 / UNC7/8 -JIS	17.0	13.0
305-00155-000-014	M24/M25-JIS	19.0	15.0
305-00155-000-042	UNC1/2-JIS	9.0	7.0

Clamp Collets

Part Number	Nominal Tap Sizes:	Shank Dia.:	Size of Square:
305-00155-000-043	UNC5/8-JIS	12.0	9.0
305-00155-000-036	M8-DIN376	6.0	4.9
305-00155-000-037	M10-DIN376	7.0	5.5
305-00155-000-038	M12-DIN376	9.0	7.0
305-00155-000-039	M14-DIN376	11.0	9.0
305-00155-000-025	M16-DIN376	12.0	9.0
305-00155-000-026	M18-DIN376	14.0	11.0
305-00155-000-027	M20-DIN376	16.0	12.0
305-00155-000-028	M22 / M24 -DIN376	18.0	14.5

■ MT3 Annular Cutter Arbors w/ 19.05 (3/4") or 31.75mm (1-1/4") Weldon Shank (For use with MD750/4, MDS750/4, MD120/4)



(2 Screws, 1 C- clip, 1 Washer, 1 O-ring, 1 Water seal , 1 Spring are included)

Part Number	Sizes:	Application
0299-0078-00000-009	ø19.05mm (212mm)	MD750/4, MD120/4
0299-0078-00000-010	ø19.05mm (237mm)	MDS750/4
0299-0078-00000-035	ø31.75mm (156mm)	MD750/4, MD120/4

■ MT3 Quick-Release Annular Cutter Arbors w/19.05 (3/4") Weldon Shank (For use with MD750/4, MDS750/4, MD120/4) (1 Spring & 1 Water seal are included)



Part Number	Sizes:	Application
0299-0078-00000-001	Single flat side with lock pin 12.3mm	MD750/4, MD120/4
0299-0078-00000-005	Single flat side with lock pin 11.7mm	MD750/4, MD120/4
0299-0078-00000-018	Two flat side with lock pin 12.3mm	MD750/4, MD120/4
0299-0078-00000-023	Two flat side with lock pin 11.7mm	MD750/4, MD120/4
0299-0078-00000-012	Single flat side with lock pin 12.3mm	MDS750/4
0299-0078-00000-015	Single flat side with lock pin 11.7mm	MDS750/4
0299-0078-00000-024	Two flat side with lock pin 12.3mm	MDS750/4
0299-0078-00000-016	Two flat side with lock pin 11.7mm	MDS750/4

*60mm maximum capacity

■ **Chuck Adaptors** (to allow mounting of a chuck for twist drilling)



Part Number	Description	Mount
302-04020-901-002	MD500/2 Chuck Adaptor for 5/8" Chucks (5/8"-16 UNF)	M27-3.0



Part Number	Description	Mount
0202-0016-00000-001	MD750/4 , MDS750/4 , MD120/4 (MT3 Machines) Chuck Adaptor for 5/8" Chucks	MT3/5/8"-16
302-04020-901-009	Chuck Adaptor for B16 Taper Mount Chucks	MT3/B16

■ **Quick-Release Chuck Adaptors**



Part Number	Description	Application
302-04240-901-001	Single flat side (shank 17.4mm) Chuck adaptor for 1/2" chuck	SMD351L, SMD351H,
302-04240-901-002	Two flat side (shank 17.4mm) Chuck adaptor for 1/2" chuck	SMD352, SMD502
302-04240-903-003	Single flat side (shank 17.9mm) Chuck adaptor for 1/2" chuck	
302-04240-903-004	Two flat side (shank 17.9mm) Chuck adaptor for 1/2" chuck	

■ **Drill Chucks & Chuck Keys**



Part Number	Description & Clamping Capacity	Mount	Application
305-00014-000-002	5/8" Chuck (w/ Key) (1mm~16mm)	5/8"-16	EVP180, MD750/4, MDS750/4, MD500/2, MD120
305-00014-000-001	1/2" Chuck (w/ Key) (1mm~13mm)	1/2"-20	EV21, MD500/2, SMD351H, SMD351L, SMD352, SMD502

■ **Pilot Pins**



Part Number	Description	Dimensions
305-00016-000-009	Pilot Pin for 12mm-17mm TCT 35L cutters	TCT - 90L x Ø6.34mm
305-00016-000-008	Pilot Pin for 18mm-60mm TCT 35L cutters	TCT - 90L x Ø7.98mm
305-00016-000-010	Pilot Pin for 12mm-17mm TCT 50L cutters	TCT - 106L x Ø6.34mm
305-00016-000-011	Pilot Pin for 18mm-60mm TCT 50L cutters	TCT - 108L x Ø7.98mm
305-00016-000-002	Pilot Pin for 12mm-100mm HSS 30L cutters	HSS - 77L x Ø6.34mm
305-00016-000-003	Pilot Pin for 12mm-100mm HSS 50L cutters	HSS - 103L x Ø6.34mm

■ **Magnetic Chip Collector**

(Push in the plunger to activate magnetic force to collect chips, Pull back the plunger to release the chips.)



Part Number	Dimensions
305-00173-000-001	400mm x 25mm

■ **Cutter Set in Case**



Part Number	Description
0299-0052-00004-001 (Black)	Includes: step pilot pin, and 30L cutters in sizes 12, 14, 16, 18, 20 & 22mm.

TAPPER

The **T14** tapper makes it convenient and easy to tap a series of holes quickly. The special gear box design gives the operator precise control:

- With no pressure on the spindle, it does not spin
- Push down on the spindle for clockwise rotation at lower speed (280/min)
- Pull up on the spindle for anticlockwise rotation at higher speed (680/min)

Its specially designed motor is wound for high torque and low rpm, giving it controllable power and making it the ideal tool for tapping applications. It includes a high concentricity universal 2-jaw tap chuck with a sprung swivel joint to minimize tap breakage. This allows it to grip any tap of any standard from M6 up to M16. The ergonomic handle helps the operator to hold the tap straight. Includes a high-leverage side handle and a depth stop for blind hole tapping.

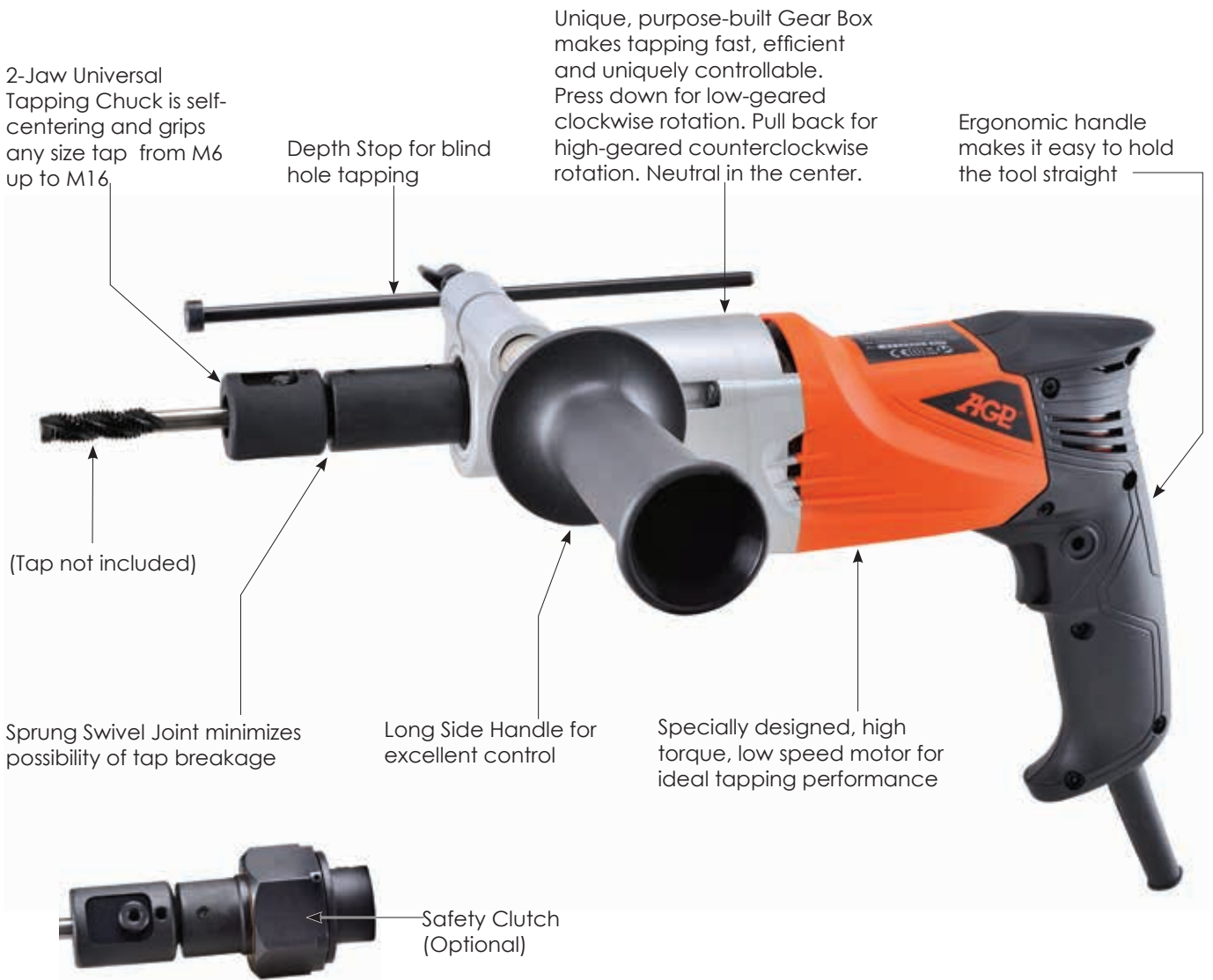

Model	T14	
Power Input	450W	
Voltage	110-120V~ 50-60Hz, 220-240~ 50-60Hz	
No Load min ⁻¹	Forward	280
	Reverse	680
Tapping Capacity	Steel	14mm (9/16")
	Aluminum	16mm (5/8")
Overload Protection	With	
Dimensions(LxWxH)	400mm x 80mm x 200mm	
Net Weight	2.7kg (5.94Lbs) (Not including side handle 0.45kg (1Lb))	

STANDARD ACCESSORIES

- * Side Handle x1
- * 4mm L-Hex Key x1
- * Depth Stop x1

OPTIONAL ACCESSORIES

- * Safety Clutch x1

DIE GRINDER & LONG NECK ANGLE GRINDER

■ Our grinder is made to be light and versatile. This makes an ideal tool for intricate grinding and polishing. The long reach spindle allows working in hard-to-reach places.

■ No matter the load, the motor keeps the same even speed.

■ Handy & compact: Excellent weight balance and superb ergonomics makes this tool easy to use.

NOTE: Models without the "N" suffix (DG50, DG50L, DG152) are equipped with electronic speed control with speed stabilization, which automatically and rigidly maintains even speed.

Models with the "N" suffix (DG50N, DG50LN, DG152N) are equipped with standard-type electronic speed control electronics. These provide better operator feel.

■ DIE GRINDER, HIGH SPEED MODEL (DG50, DG50N)

Long-Reach Spindle



■ DIE GRINDER, LOW SPEED MODEL (DG50L, DG50LN)

Large thumb switch

Collet



■ LONG NECK ANGLE GRINDER (DG152, DG152N)

The Long Neck Angle Grinder allows grinding in hard to reach areas where a conventional grinder could not fit.

Speed Control Thumb Wheel with Electronic Speed Stabilization maintains speed under load



(DG50, DG50L, DG152 ONLY)



Model	DG50	DG50N	DG50L	DG50LN	DG152	DG152N
Power Input	1200W					
Voltage	110-120V~ 50-60Hz, 220-240V~ 50-60Hz					
No Load min ⁻¹	10,000 - 28,000		2,700 - 6,000		2000 - 4500	
Collet	6mm *					
Max. Wheel Diameter	50mm				150mm	
Dimensions (LxWxH)	400mmX 72mm X 77mm		510mmX 72mm X 77mm		590mm x 165mm x 130mm	
Soft Start & Overload Protection	With					
Net Weight	2.0kg (4.41 Lbs)		2.2kg (4.85 Lbs)		3.5kg (7.72 Lbs)	

STANDARD ACCESSORIES

DG50:
* Wrench 17mm x1
* Wrench 12mm x1

DG50L:
* Wrench 19mm x 25mm
2PCS x1

DG152:
* Hex. Wrench M6 x1
* Lock Nut Wrench x1

*DG50 Collet (Size : 3mm & 6mm & 6.35mm Available) DG50L Collet (Size: 6mm & 6.35mm & 8mm Available)

SLIMLINE ANGLE GRINDERS

The Slimline Angle Grinders have a motor housing which is just 56mm in diameter, making them extremely comfortable to use for long periods and easy to guide precisely.

This makes them a very light and nimble grinder, and the 780 watt motor gives them excellent, usable power. The motors are made to last, with machined and hardened gears and top quality motor components. The optimized motor engineering leads to very cool running and excellent performance, even when used continuously.

There are two versions to choose from: A100 with top-mounted slider switch, B100 with tail-mounted toggle switch.



Description
Side Handle

Part Number
203-0001-00000-002



Model	A100	B100
Power Input	780W	780W
Voltage	110-120V~ 50-60Hz, 220-240V~ 50-60Hz	
No Load min ⁻¹	12,000	12,000
Spindle	M10-1.5	M10-1.5
Max. Wheel Diameter	100mm (4")	100mm (4")
Dimensions(LxWxH)	280mm x 120mm x 93mm	
Net Weight	1.5kg (3.3Lbs)	1.5kg (3.3Lbs)

STANDARD ACCESSORIES

* Lock Nut Wrench x1

OPTIONAL ACCESSORIES

* Side Handle x1

ANGLE GRINDER & STRAIGHT GRINDER

Our **AG9 Angle grinder** is made to be powerful for heavy duty applications. This makes an ideal tool for grinding and cutting. The Anti-vibration side handle allows working in comfort. The 2200w motor is equipped with variable full wave electronic speed stabilization for a smooth even finish. No matter the load, the motor keeps the same even speed. The machined gears ensure maximum service life.

Our **SG6 grinder** combines solid mechanical construction with advanced electronic speed stabilization circuitry for outstanding performance, whether grinding or polishing.

■ ANGLE GRINDER (AG9)

Speed control thumb wheel with various speed

Spindle Lock

On / Off Switch

9" Dust Collector Saw Cover

Wheel (Optional)

Professional Grade Motor with Overload Protection and Soft-Start

Anti-vibration side handle

Vacuum port: 38mm O.D., 32mm I.D.

Description

9" Dust Collector Saw Cover

(A Type) Mounting plate fixes to the cover with pan head screws for extra clearance with grinders with large gear boxes.

Clamping size:
55~60mm
70~75mm

Part Number

0299-0063-00000-015
0299-0063-00000-016

(B Type) Mounting plate fixes to the cover with tool-free T-Knobs. May cause clearance problems for grinders with large gear boxes. If so, use A Type .

Clamping size: **Part Number**
55~60mm 0299-0063-00000-008
70~75mm 0299-0063-00000-009
(For 5" covers, please see p.65)



■ STRAIGHT GRINDER (SG6)

Adjustable Guard

Speed Control Thumb Wheel

Trigger Switch

High Output Motor with Electronic Speed Stabilization maintains speed under load

Hand Grip

Wheel (Optional)



Model	AG9	SG6
Power Input	2200W	110-120V:1300W, 220-240V:1500W
Voltage	110-120V~ 50-60Hz, 220-240V~ 50-60Hz	
No Load min ⁻¹	3000 - 6500	1600 - 4800
Spindle	M14	M14 (W/ 20mm Tool Holder)
Max. Wheel Diameter	230mm (9")	150mm (6")
Dimensions (LxWxH)	504mm x 240mm x 146mm	566mm x 80mm x 96mm
Soft Start & Overload Protection	With	With
Net Weight	5.3kg (11.68 Lbs)	3.4kg (6.61 Lbs)

STANDARD ACCESSORIES

AG9:
* Lock Nut Wrench x1
* Anti-Vibration Side Handle x1

SG6:
* Face Spanner Wrench x1
* Mandrel Arbor x1
* Wrench M17 x1
* Wrench M22 x1
* Wrench M5 x1

OPTIONAL ACCESSORIES

* Wheel x1

WRAPAROUND TUBE SANDER / POLISHER

The machine especially designed for finishing tube forms.

This tool makes it incredibly fast and easy to finish closed or open tube forms, such as railings, etc. With different belts, you can rough sand and fine sand to remove surface imperfections, blend, create surface effects like satin or brush finishes, all the way to mirror polishing. The quick-change belts allow you to easily change between different grits and grades of compound. The high efficiency motor has soft start, overload protection and electronic speed stabilization for maximum power and even speed. The speed is set with the thumb wheel and remains stable. This results in consistently excellent finish quality. The arms allow the belt to wrap around the surface to contact from 180 up to 270 deg. of the tube at a time. There is no easier or faster way to deal with tube constructions!



Surface Conditioning Belt

Sandpaper Belt



Plastic Carry Case

Description

- Plastic Carry Case 572mm x 362mm x 238mm
- Surface Conditioning Belt (40 x 760mm)
- Sandpaper Belt #120 grit (40 x 760mm)
- Sandpaper Belt #220 grit (40 x 760mm)

Part Number

- 0299-0075-00100-011
- 305-00043-000-002
- 305-00045-000-009
- 305-00045-000-010



Model	WS760
Power Input	110-120W:850W, 220-240V:1200W
Voltage	110-120V~ 50-60Hz, 220-240V~ 50-60Hz
No Load min ⁻¹	1600 - 3200
Surface Speed	3~12 m/sec
Max. Belt (L) x (W)	760mm x 40mm
Max. Pipe Diameter	180mm
Max. Polishing Deg.	270
Soft Start & Overload Protection	With
Dimensions(LxWxH)	530mm x 370mm x 215mm
Net Weight	3.1kg (6.83 Lbs)

STANDARD ACCESSORIES

- * Side Handle x1
- * Surface Conditioning Belt (40 x 760mm) x1
- * Sandpaper Belt #120 grit (40 X 760mm) x5
- * Sandpaper Belt #220 grit (40 X 760mm) x5

WRAPAROUND TUBE SANDER / POLISHER

- The powerful motor is equipped with electronic speed stabilization for a smooth even finish.
- No matter the load, the motor keeps the same even speed.
- High stability belt tracking. All pulleys are flanged so the belts stay on under all conditions.
- Quick, tool free belt changes .
- Perfect for grinding down weld seams.
- Follows the curved contours of pipes and other convex work surfaces.

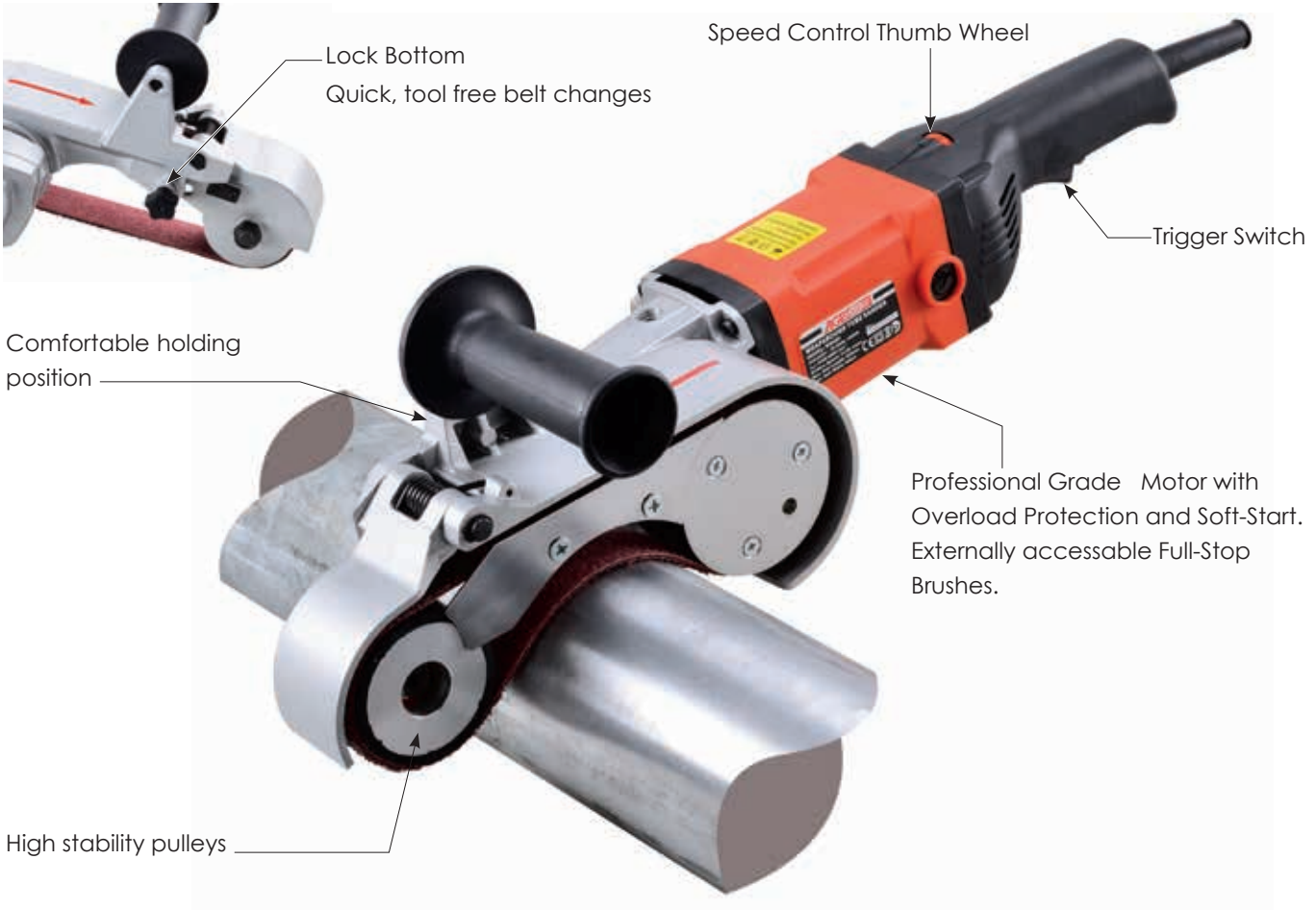

Surface Conditioning Belt



Sandpaper Belt

Description

Sandpaper Belt #60 (40 x 620mm)
 Sandpaper Belt #100 (40 x 620mm)
 Sandpaper Belt #180 (40 x 620mm)
 Surface Conditioning Belt (40 x 620mm)

Part Number

305-00045-000-006
 305-00045-000-007
 305-00045-000-008
 305-00043-000-003



Model	WS620
Power Input	110-120V:1300W, 220V-240V:1500W
Voltage	110-120V~ 50-60Hz, 220-240V~ 50-60Hz
No Load min ⁻¹	2300 - 6500
Surface Speed	15 - 28 m/sec
Max. Belt (L) x (W)	620mm x 40mm
Dimensions(LxWxH)	601mm x 220mm x 182mm
Soft Start & Overload Protection	With
Net Weight	4.8kg (10.58 Lbs)

STANDARD ACCESSORIES

- * Side Handle x1
- * Sandpaper Belt #60 (40 x 620mm) x1
- * Sandpaper Belt #100 (40 x 620mm) x1
- * Sandpaper Belt #180 (40 x 620mm) x1
- * Surface Conditioning Belt (40 x 620mm) x1

DRUM SANDER / POLISHER

With this versatile finishing machine, one can go from rough surface sanding and deburring all the way to mirror polishing with one tool. The linear rotation makes this tool perfect for flat surfaces. It does a job that an angle grinder's rotary motion can never do. It works wonderfully smoothing, removing scratches and blending. It makes it easy to create surface effects such as matte, satin and brush finishes. Can create swirl-free high-polish and mirror polish finishes. This is also an ideal tool for maintaining, cleaning and polishing old metal surfaces.

- The 1200W motor is equipped with electronic speed stabilization for a smooth even finish.
- No matter the load, the motor keeps the same even speed.
- The inflatable rubber sanding drum has a wide variety of sleeves available. The rubber cushion follows the surface contours of the work piece for an unbeatable finish.
- The drive pulley runs inward-facing belts for finishing tube forms. The hook & loop closing straps allow the belts to be opened and closed around closed tube forms. Bulk sanding rolls can be turned into belts.



Plastic Carry Case
572mm x 362mm x 238mm

Part Number
0299-0075-00100-006



Model	DP100
Power Input	1200W
Voltage	110-120V~ 50-60Hz, 220-240V~ 50-60Hz
No Load min ⁻¹	1500~2800
Max. Wheel Diameter	100mm
Max. Wheel Width	100mm
Arbor	19mm double keyed x 100mm long
Soft Start & Overload Protection	With
Dimensions(LxWxH)	394mm x 198mm x 195mm
Net Weight	3.5kg(7.71Lbs)

Drive Pulley for Belts



Drive Pulley for inward-facing belts

Hook & Loop openable and re-closable belts for finishing closed tube forms. (H&L closing straps included) Can use:

- * Sanding Belts in various grits.
- * Fine Sanding Sponge Belts
- * Surface Conditioning (Fleece) Belts
- * Felt Buffing Belts.

Surface Conditioning Flap Wheel



100 x 19mm arbor with double keys can fit various:

- * Flap Wheels
- * Abrasive Wheels
- * Buffing Wheels (mops).

Narrower wheels can be fitted using arbor spacers (included)

STANDARD ACCESSORIES KIT

Plastic Carry Case 572mm x 362mm x 238mm

Part Number

299-0075-00100-006

Inflatable Rubber Sanding Drum



Inflatable Rubber Sanding Drum x1

Part Number

0299-0016-00000-001



Surface Conditioning Sleeve (100 x 292mm) x1
Sandpaper Sleeve #60 x1
Sandpaper Sleeve #100 x1
Sandpaper Sleeve #180 x1

305-00041-004-001

305-00043-000-001

305-00045-000-001

305-00045-000-002

305-00045-000-003

Drive Pulley for Belts

(All belts with 45 degree slit for opening and closing)



Drive Pulley for Belts x1

303-01073-005-001



Surface Conditioning Belt (40 x 600mm) x1

305-00046-000-001



Sandpaper Belt #120 Grit (40 x 600mm) x1

305-00048-000-001



Hook & Loop Belt Closing Straps (30 x 700mm) x1

305-00049-000-001

Surface Conditioning Flap Wheel



Surface Conditioning Flap Wheel (100 x 100 x 19mm) x1

305-00042-000-001



Arbor Spacer Discs (35 x 19 x 5mm) x1
(for fitting narrower wheels to the arbor)

303-01021-004-002

ELECTRIC SHEAR

The **ST301** is versatile and dependable sheet metal shear. The shear head swivels 360 degrees and can easily cut straight or curved lines. The ergonomic grip allows maximum control and operator comfort. Cutting operation removes a 5.6mm curled strip of material and leaves adjacent metal flat. Cuts up to 1.2mm (18 ga.) in mild steel and 1.0mm (20 ga.) in stainless. Replaceable high speed steel blades.



The shear head swivels 360 degrees and can easily cut straight or curved lines

Trigger Switch

Lock Button

Model	ST301
Power Input	550W
Voltage	110-120V~ 50-60Hz, 220-240V~ 50-60Hz
No Load/min ⁻¹	2500 SPM
Max. Capacity	Copper, Aluminum: 1.5mm (16ga.)
	Steel: 1.2mm (18ga.)
	Stainless Steel: 1.0mm (20ga.)
Dimensions(LxWxH)	300mm x 65mm x 185mm
Weight	1.7kg (3.7 Lbs)

STANDARD ACCESSORIES

N/A



SHEET METAL NIBBLER

The **LY16** is an excellent all-around nibbler for sheet metal fabricators, body shops, tin smiths and the like. The slim body makes it comfortable to hold and to guide precisely. The die is adjustable to any of 3 positions. The powerful, yet compact motor delivers 2300 strokes per minute for fast, controllable cutting in a variety of materials. Clean, burr-free cuts in up to 16 ga in steel and 18 ga in stainless.

Locking slider switch easy to operate wearing gloves

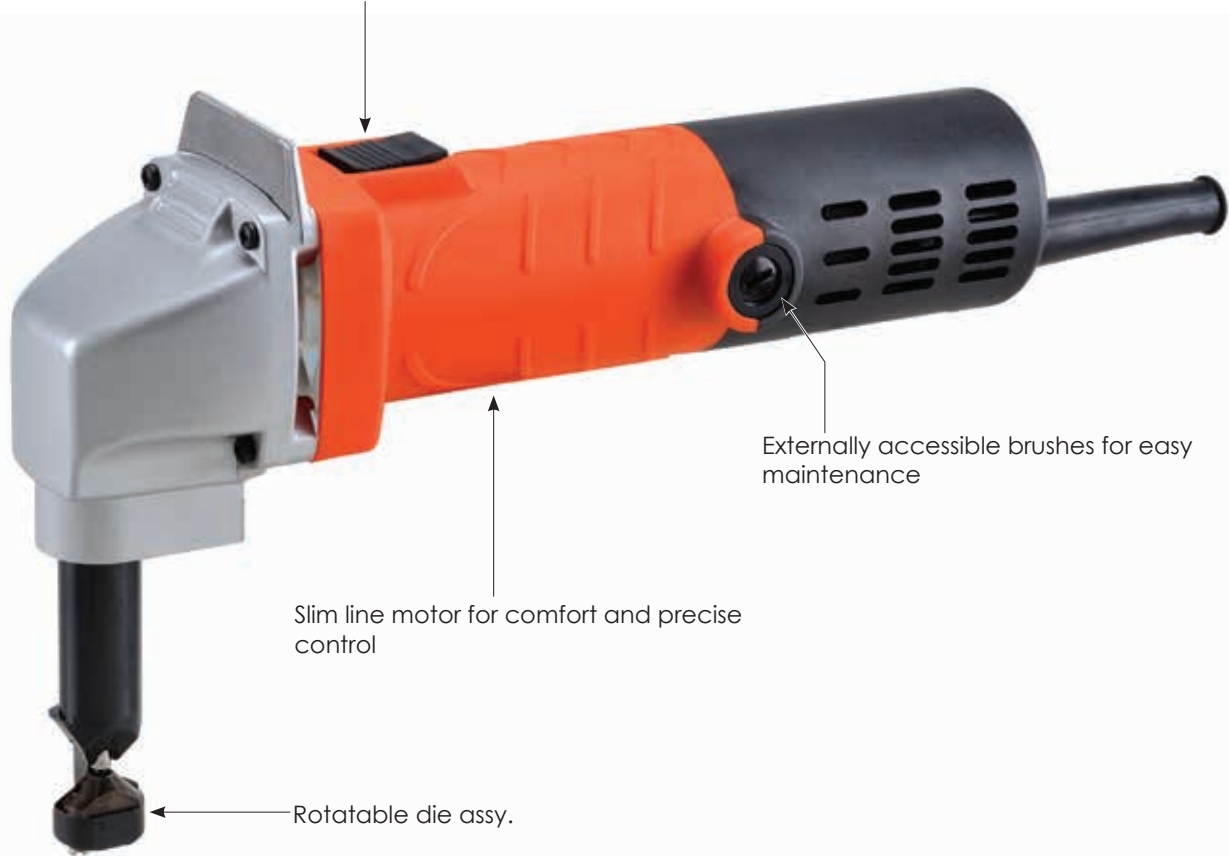

Externally accessible brushes for easy maintenance

Slim line motor for comfort and precise control

Rotatable die assy.



Model	LY16	
Power Input	500W	
Voltage	110-120V~ 50-60Hz , 220-240V~ 50-60Hz	
No Load/min ⁻¹	2300 SPM	
Min. Cut Radius	40mm	
Max. Capacity	Steel	1.6mm (16 ga.)
	Stainless Steel	1.2mm (18 ga.)
Dimensions(LxWxH)	790mm x 270mm x 730mm	
Net Weight	1.5kg (3.3Lbs)	

STANDARD ACCESSORIES

* Hex Key M2.5 x1

* Hex Key M4 x1

HIGH FREQUENCY BEVELING SYSTEM

The HP1400 high frequency beveler, in conjunction with the P3000 converter make an unbeatable beveling system. They take advantage of the benefits of high frequency to provide maximum beveling performance under continuous use. High frequency allows unprecedented power to weight ratio as well as extremely even speed for outstanding beveling results and longer life for the consumables. High frequency also has the benefits of long duty cycles, long motor life, and quiet operation. The motor is brushless and maintenance free.

The HP1400 is equipped with a 45 deg. tool holder which uses 3 standard sized indexable square carbide inserts for chatter-free beveling results. A 30 deg. tool holder as well as various radius cutting inserts are optionally available. The operating speed is set at the converter and is adjustable from 6000-8550 rpm in increments of 150. The converter is unique in that it can accept both single and three phase current.

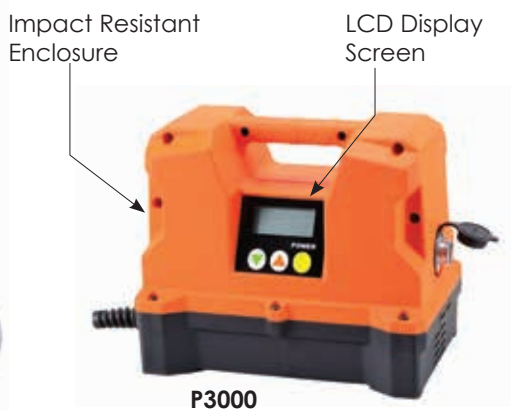

High Frequency Shielded Coupling Cable (Please indicate required length when ordering).

Replacement Carbide Inserts (Box of 10)



	Part Number
Straight Bevel	305-00051-000-007
R2.5 Radius	305-00051-000-008
R3.5 Radius	305-00051-000-009
R4 Radius	305-00051-000-010



High Frequency Beveler	
Model	HP1400
Power output	1400W
No Load min ⁻¹	6000-8550
Bevel Angle	45 Deg.(Optional 30 Deg.)
Max. Bevel Height (45 Deg.)	6mm
Min. Diameter For Inside Bevels	30mm
Dimensions (LxWxH)	310mm x 150mm x 150mm
Net Weight	3.9kg (8.6Lbs)

STANDARD ACCESSORIES

- * Anti- Vibration Side Handle x1
- * Torx Wrench T15 x1
- * Hook Spanner Wrench x1
- * Face Spanner Wrench x1
- * 45 Deg. Tool Holder Set x1
- * Square Carbide Inserts x3
- * Hex Wrench M14 x1

OPTIONAL ACCESSORIES

- * 30 Deg. Tool Holder Set x1
- * R2.5mm inserts x10
- * R3.5mm inserts x10
- * R4.0mm inserts x10
- * 10m coupling cable x1
- * 20m coupling cable x1
- * 30m coupling cable x1

Converter	
Model	P3000
Voltage	200-240V 50/60Hz, single phase / 3 phase
Input	3.0 KVA
Output	8A, 1600W, 210V, 200-285 Hz
Dimensions (LxWxH)	260mm x 160mm x 215mm
Net Weight	2.65kg (5.83Lbs)

ELECTRIC BEVELER

- The quick and convenient solution for adding bevels and deburring.
- Excellent for following curved shapes.
- Variable speed for working with a variety of materials.
- Uses standard triangle carbide inserts.
- Quick and easy tool-free bevel depth setting



Model	EB6
Power Input	1100W
Voltage	110-120V~ 50-60Hz, 220-240V~ 50-60Hz
No Load min ⁻¹	3000 - 6000
Bevel Angle	45 Deg.(Optional 30 Deg.)
Max. Bevel Height (45 Deg.)	6mm
Min. Diameter For Inside Bevels	20mm
Dimensions(LxWxH)	308mm x 344mm x 273mm
Net Weight	4.3kg (9.48 Lbs)

STANDARD ACCESSORIES

- * Torx Wrench T15 x1
- * Hook Spanner Wrench x1
- * Spindle Lock Bar x1
- * 45 Deg. Tool Holder Set x1
- * Square Carbide Inserts x2

OPTIONAL ACCESSORIES

- * 30 Deg. Tool Holder Set x1

ELECTRIC BEVELER

- The quick and convenient solution for adding bevels and deburring.
- Excellent for following curved shapes.
- Variable speed with soft start for working with a variety of materials.
- Uses standard indexible square carbide inserts.(Radius cutting inserts optionally available.)
- Quick and easy tool-free bevel depth setting.
- Comes standard with a 45 deg. tool holder. (30 deg. tool holder optionally available)



Auxiliary Handle

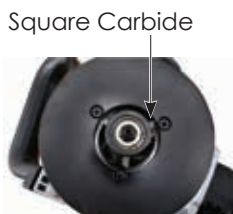

Square Carbide

3 Indexable square carbide inserts: ISO SEMT13T3

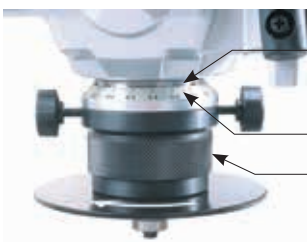

Bevel Height Scale

Adjustable Dial Ring

Support Deck



Plastic Carry Case
352mm x 257mm x 312mm

Part Number
0299-0075-00100-007

Carbide Insert
(Optional Radius
Cutting Insert
shown)



Three Insert Tool Holder

Replacement Carbide Inserts (Box of 10)



Straight Bevel



R2.5 Radius



R3.5 Radius



R4 Radius

Straight Bevel
R2.5 Radius
R3.5 Radius
R4 Radius

Part Number
305-00051-000-007
305-00051-000-008
305-00051-000-009
305-00051-000-010



Model	EB6T
Power Input	1100W
Voltage	110-120V~ 50-60Hz, 220-240V~ 50-60Hz
No Load min ⁻¹	3000 - 6000
Bevel Angle	45 Deg.(Optional 30 Deg.)
Max. Bevel Height (45 Deg.)	6mm
Min. Diameter For Inside Bevels	30mm
Dimensions (LxWxH)	308mm x 344mm x 273mm
Net Weight	4.5kg (9.92 Lbs)

STANDARD ACCESSORIES

- * Torx Wrench T15 x1
- * Hook Spanner Wrench x1
- * Spindle Lock Bar x1
- * 45 Deg. Tool Holder Set x1
- * Square Carbide Inserts x2

OPTIONAL ACCESSORIES

- * 30 Deg. Tool Holder Set x1
- * R2.5mm inserts x10
- * R3.5mm inserts x10
- * R4.0mm inserts x10

ELECTRIC BEVELER

- The **EB12** is a heavy-duty hand held beveler which uses 6 indexable carbide inserts for chatter-free beveling. The design allows straight edges, contours and cutouts to be beveled with ease.
- Works with steel, stainless steel, aluminum, copper, plastic and other materials.
- The precision dial scale allows precise adjustment of the chamfer height.
- Variable electronic speed control allows stable cutting speed, no matter the load, for precision results with various materials.

Speed Control Thumb Wheel. Electronic Speed Stabilization Circuitry maintains speed under load

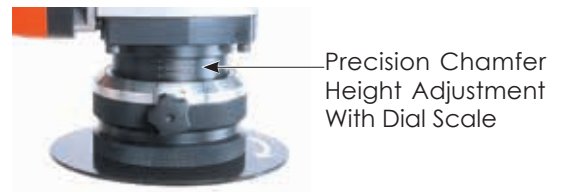

Precision Chamfer Height Adjustment With Dial Scale

Replacement Carbide Inserts (Box of 10)



Straight Bevel

Part Number

Straight Bevel 305-00051-000-006



6 Carbide Insert Tool Holder Set

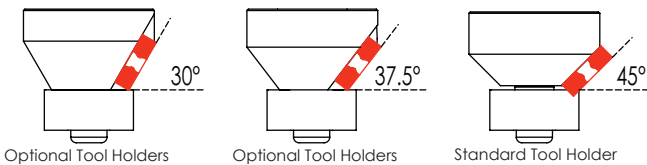

Optional Tool Holders

Optional Tool Holders

Standard Tool Holder



Plastic Carry Case
572mm x 362mm x 238mm

Part Number

0299-0075-00100-008



Model	EB12
Power Input	1800W
Voltage	110-120V~ 50-60Hz, 220-240V~ 50-60Hz
No Load min ⁻¹	2300 - 6500
Speed Wheel Settings	1/ 2/ 3/ 4/ 5/ 6: 2300/ 2600/ 3700/ 4800/ 5800/ 6500
Std. Bevel Angle	45 Deg.
Max. Chamfer Height	45 Deg. : 10.6 mm
Mini. Dia. For Inside Bevels	30 mm
Soft Start & Overload Protection	With
Dimensions (LxWxH)	485mm x 192mm x 150mm
Net Weight	6.35kg(14Lbs)

STANDARD ACCESSORIES

- * 45 Deg. Tool Holder Set x1
- * Square Carbide Inserts x6
- * Torx Wrench T15 x1
- * Hex. Wrench M6 x1
- * Hook Spanner Wrench x1
- * Spindle Lock Bar x1

OPTIONAL ACCESSORIES

- * 30 Deg. Tool Holder Set x1
- * 37.5 Deg. Tool Holder Set x1

ELECTRIC BEVELER

The Electric Beveler EB 24 comes with an AC induction motor which offers longer durability and lower noise, as well as its high torque. The milling angle is adjustable progressively from 15° to 60° with a maximum land width of 21.9 mm. With weight only 19.3 kg, its very handy, compact and robust design allows for easy handling and convenient operation



12 Carbide Insert Tool Holder ISO SPKN120308

Angular Adjustment from 15-60 Deg.

Replacement Carbide Inserts (Box of 12)

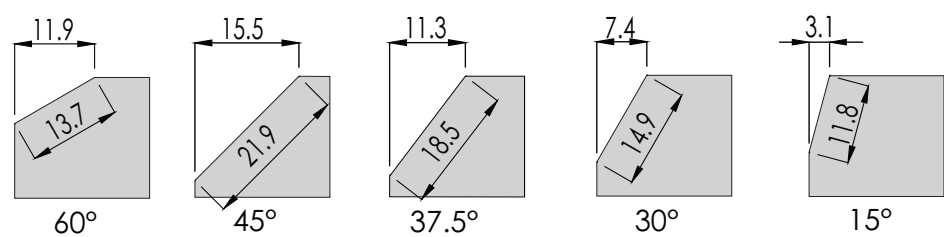

Straight Bevel

Straight Bevel

Part Number
305-00051-000-001



Model	EB24	
Power Input	1100W	
Voltage	110-120V~ 50-60Hz, 220-240V~ 50-60Hz	
No Load min ⁻¹	60Hz: 3600 , 50Hz: 3000	
Angular Adjustment	60 Deg.	13.7mm
	45 Deg.	21.9mm
	37.5 Deg.	18.5mm
	30 Deg.	14.9mm
	15 Deg.	11.8mm
Dimensions (LxWxH)	475mm x 296mm x 247mm	
Net Weight	19.3 kg (42.46 Lbs)	

STANDARD ACCESSORIES

- ** Milling Disc, x2
- * Square Carbide Inserts x12
- * Hex. Wrench M8 x1
- * Hex. Wrench M3 x1
- * M 32 Combination Wrench x1
- * Open End Wrench 27mm X 24mmx1

ELECTRIC BEVELER

The Electric Beveler **EB24R** comes with an AC induction motor which offers even cutting speed, longer durability, lower noise and excellent torque characteristics. The milling angle is adjustable progressively from 0° to 60° with a maximum land width of 21 mm. With a weight only 20.3 kg, its very handy, compact and robust design allows for easy handling and convenient operation. This extremely versatile beveler is able to bevel pipes, perform facing off and a variety of bevels from zero to 60 deg. The special convertible table plate can switch between plate beveling and pipe beveling just by repositioning the guide rollers. The pipe beveling position is adjustable to allow a range of pipe sizes from 150 to 350mm. And if larger sizes are required, the optional table plate allows pipes 300 to 600mm.



Plate Facing-off:
0 Deg.

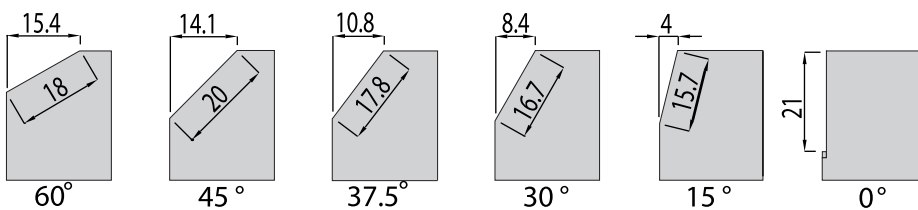

Plate Beveling



Pipe Beveling

Bevel widths on straight and round materials.



Replacement Carbide Inserts
(Box of 12)



Straight Bevel

Straight Bevel

Part Number

305-00051-000-001



Model	EB24R	
Power Input	1100W	
Voltage	110-120V~ 50-60Hz, 220-240V~ 50-60Hz	
No Load min ⁻¹	60Hz: 3600, 50Hz: 3000	
Angular Adjustment	Angle	Max. Bevel Width
	60 Deg.	18mm
	45 Deg.	20mm
	37.5 Deg.	17.8mm
	30 Deg.	16.7mm
	15 Deg.	15.7mm
	0 Deg.	21mm
Pipe beveling	150mm - 350mm (Standard), 300mm-600mm(Optional)	
Dimensions(LxWxH)	503mm x 350mm x 248mm	
Net Weight	20.1kg(44.31Lbs)	

STANDARD ACCESSORIES

- * Milling Disc, x2
- * Square Carbide Inserts x12
- * L-Hex. Wrench M8 x1
- * L-Hex. Wrench M3 x1
- * M 22 Open End Wrench x1
- * M 32 Combination Wrench x1
- * M27 x M24 Double Open End Wrench x1
- * Zero Degree Milling Receiver x1
- * Bevel Milling Receiver x1

OPTIONAL ACCESSORIES

- * Large Table Plate
(for pipes 300-600mm) x1

METAL CUTTING CIRCULAR SAWS

- Purpose built for using TCT metal cutting blades to cut Steel, Stainless Steel, Aluminum, and other metals. Amazing performance cutting metals as easily as conventional circular saws cut wood. Cuts efficiently and keeps cool.
- Super-quick chip clearing with our unique bayonet-type blade cover latch.
- Ergonomic handle shape and position with soft TPR grip the result of extensive lab testing for maximum comfort and fatigue free operation.
- Can make bevel cuts up to 45 degrees. We did not forget convenience, either. Our saws provide easy to read positive stops for all the most popular bevel angles, plus quick and easy adjustment.
- High stability base with quick, tool-free depth adjustment including clearly marked scale.
- High output motors for all the torque you need to perform even the most challenging cuts.
- Safety features include a lock-off switch and spark/chip containing design.
- Every feature comes together to provide exact, clean cuts with a variety of metals.



Quick, Tool-Free Depth Adjustment

Speed Control (Optional)



Side Handle affixed to the base gives superior stability during bevel cuts.



Bevels up to 45 degrees



Model	CS200	CS230N
Power Input	1700W	1700W
Voltage	110-120V~ 50-60Hz, 220-240V~ 50-60Hz	
No Load min ⁻¹	3700	2200
Bevels	0 to 45 Degrees	0 to 45 Degrees
TCT Saw Blade	200 mm (8 in.)	230 mm (9 in.)
Arbor	30mm (1-3/16 in.) or 25.4mm (1 in.)	30mm (1-3/16 in.) or 25.4mm (1 in.)
Cutting Capacities	Straight cut: 67 mm (2-5/8 in.)	Straight cut: 80mm (3- 1/4 in)
	45 Degree Bevel: 42mm (1-5/8 in.)	45 Degree Bevel: 56mm (2-3/16 in.)
Dimensions(LxWxH)	368mm x 284mm x 330mm	383mm x 301mm x 360mm
Net Weight	7.1kg(15.62Lbs)	8.2kg(18.04Lbs)

STANDARD ACCESSORIES

- * Side Handle x1
- * Hex. Wrench M6 x1

OPTIONAL ACCESSORIES

- * Speed Control Device
- * Soft Start & Overload Protection Unit
- * TCT Saw Blade(see p.62)

With its large 320mm blade and over 121mm (on guide rail) depth of cut, this is the perfect saw for neat, on-site cutting of sandwich panels.

Before now, the only options for cutting sandwich panel on-site were jig saws and reciprocating saws. These methods leave a lot to be desired. First, it is difficult to guide them well enough to make an accurate cut, especially over deep corrugations. Second, the reciprocating action can damage the anti-corrosion coating on the flashing. And third, there is no method of controlling the large amounts of dust and debris from the insulation. All that is solved with this saw!

The optional guide rail makes long and accurate cuts fast and easy, even with deeply corrugated panels. Includes a unique dual mode dust collection system: The patented dust chamber collects most of the debris, even the foam insulation, and is super quick and easy to dump out. Or use a vacuum cleaner connected to the dust extractor port for even more complete dust control. High efficiency 1800 watt motor with outstanding torque characteristics. The load indicator light alerts the operator to approaching overload. Smart motor electronics include soft-start and overload protection. Of course, this saw isn't limited to sandwich panels, it's an effective, large capacity saw for a variety of metals like steel and aluminum as well as plastics!

Unique, patented dust chamber cover opens and snaps closed in seconds. Highly effective dust and debris collection.

Large cutting capacity provided by the 320mm metal cutting blade. A full 121mm depth of cut when mounted on a guide rail.

Kicker Lever for opening the lower blade guard on thick, soft-cored sandwich panels

Load Indicator Light

Guide Clearance Adjustor



OPTIONAL ACCESSORIES:



The guide rail allows perfectly straight cuts and the cut-to-fit rubber strip shows the operator exactly where the cutting line will be.

Aluminum Guide Rails Spec.

Guide Rail	174mm x 1400mm
Guide Rail	174mm x 800mm



Guide Rail Connector



Lever Clamp

Description

Guide Rail Connector
Lever Clamp

Part Number

0299-0106-00000-001
305-00179-000-001



Model	CS320
Power Input	110-120V: 1700W, 220-240V: 1800W
Voltage	110-120V~ 50-60Hz, 220-240V~ 50-60Hz
No Load Min ⁻¹	1700
Max Blade Diameter	320mm
Arbor Hole Diameter	25.4mm (1 Inch)
Max Cutting Depth	128mm (121mm On Guide Rail)
Soft Start & Overload Protection	With
Dimensions(LxWxH)	500mm x 342mm x 355mm
Net Weight	8.4kg (18.52 Lbs)

STANDARD ACCESSORIES

- * 6mm Hex Wrench x1
- * Side Handle x1

OPTIONAL ACCESSORIES

- * TCT Saw Blade (See p.62)

355mm (14") DRY-CUT METAL SAW

The **DRC355** uses the latest innovations in saw blade technology to dry-cut steel, aluminum, stainless steel, and other metals. The dry cut saw blade shears through the material more than 3 times faster than traditional cut-off saws with abrasive wheels. A with less sparks, less heat and the resulting cut is accurate, clean and practically free of burrs.

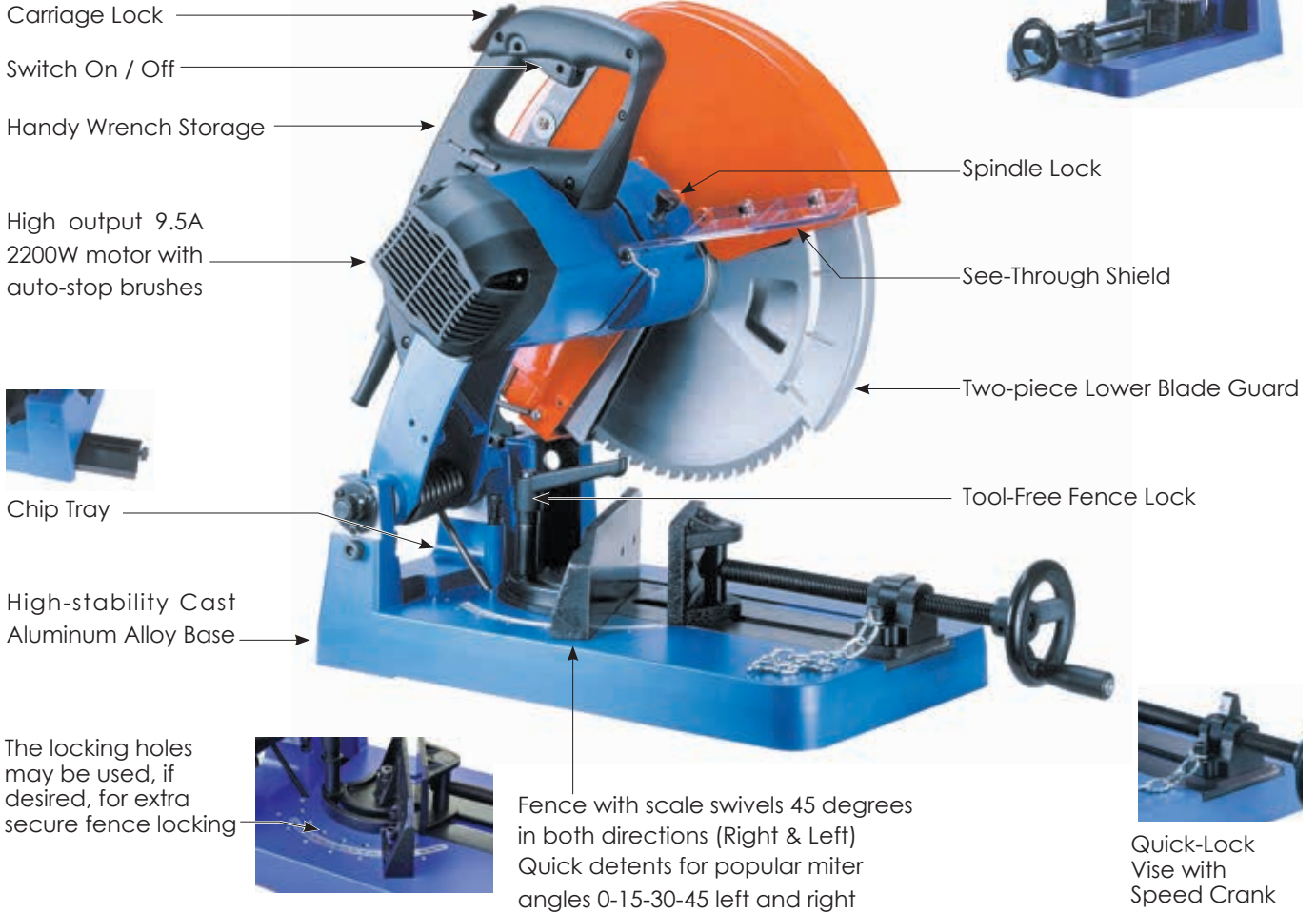

V-Jig Block

Part Number
201-0030-00902-001



Safety Goggles

Part Number
305-00056-000-001



Lever Clamp

Part Number
305-00179-000-001

Model	DRC355			
Power Input	2200W			
Voltage	110-120V~ 50-60Hz, 220-240V~ 50-60Hz			
No Load min ⁻¹	1300			
Max. Cutting Capacities	90 deg.	Round Pipe	132mm	
		Square Stock	120mm (W) x 120mm(H)	
		Rectangular Stock	180mm(W) x 100mm(H)	
	Right Hand Miter			
	45 deg.	Round Pipe	105mm	
		Square Stock	90mm(W) x 90mm(H)	
		Rectangular Stock	90mm(W) x 120mm(H)	
	Left Hand Miter			
	25 deg.	80mm(W) x 120mm(H)		
	30 deg.	90mm(W) x 120mm(H)		C-clamp required
35 deg.	80mm(W) x 120mm(H)		C-clamp required	
45 deg.	70mm(W) x 120mm(H)		C-clamp required	
Arbor	25.4mm (1")			
Soft Start	With			
Dimensions(LxWxH)	680mm x 360mm x 580mm			
Net Weight	24.6kg (54.23 Lbs)			



STANDARD ACCESSORIES

- * 4 mm Hex. Wrench x1
- * 6 mm Hex. Wrench x1
- * 8 mm Hex. Wrench x1
- * Chip Tray

OPTIONAL ACCESSORIES

- * V-Jig Block x1
- * Safety Goggles x1
- * Lever Clamp x1
- * TCT Saw Blade (See P.62)

DIGITAL BENDING MACHINE

The DB 32 Portable Digital Bending Machine is unique in the industry in having a digital LCD degree display. It makes it extremely fast and simple to produce accurate bends up to 190 degrees in tubing up to 1-1/2". Simply set the desired degree of bend with the thumb wheel and that number appears on the digital display. As soon as the trigger is pressed, the actual degrees of bend are displayed, up until the bend is completed.

The robust 1700 watt motor and heavy duty gear box are built to last.

Bends are made quickly at 3.5 rpm.

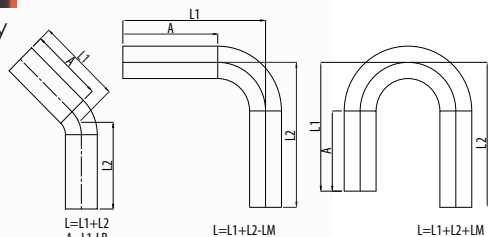
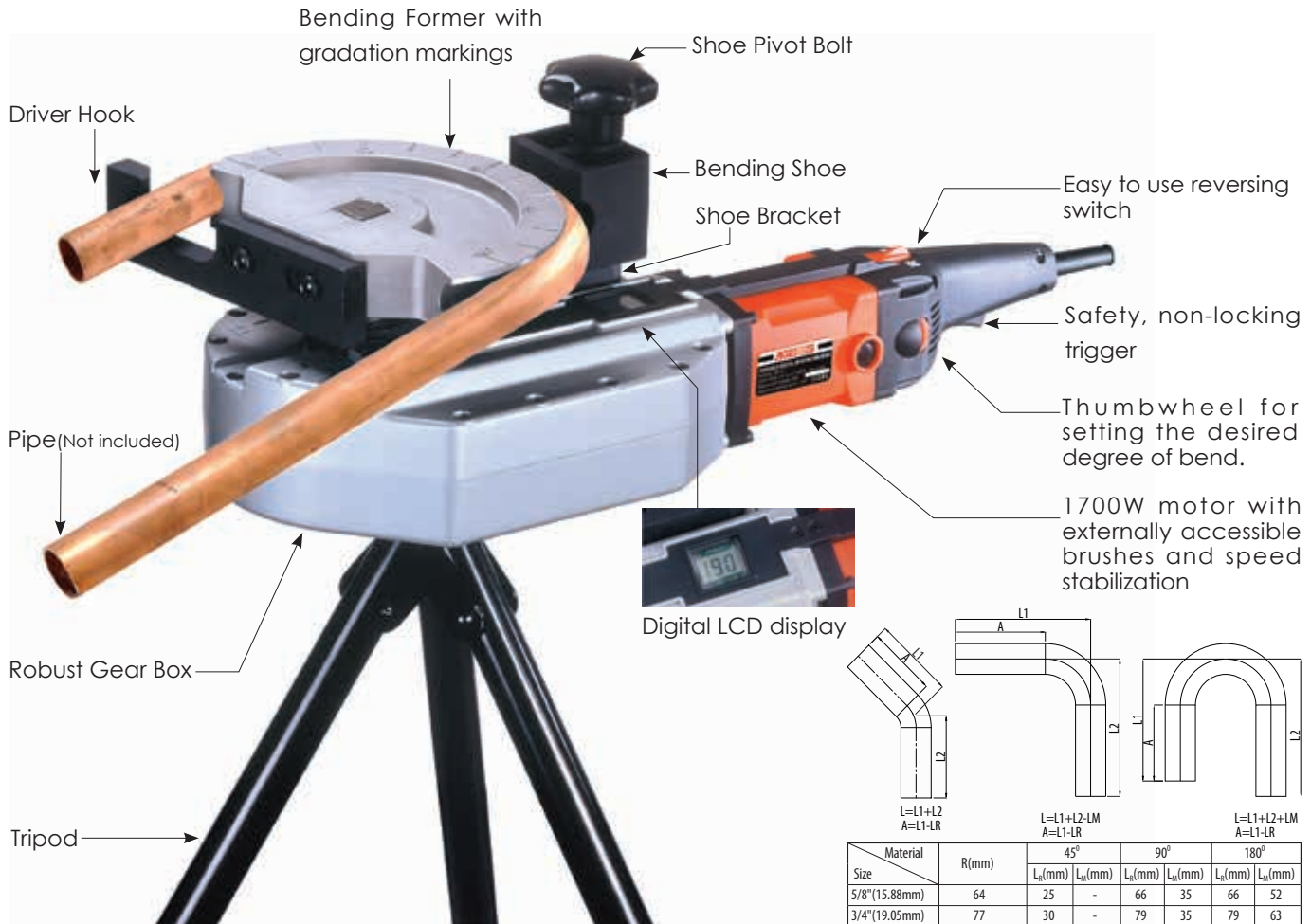

Material	R(mm)	45°		90°		180°	
		L ₁ (mm)	L ₂ (mm)	L ₁ (mm)	L ₂ (mm)	L ₁ (mm)	L ₂ (mm)
5/8" (15.88mm)	64	25	-	66	35	66	52
3/4" (19.05mm)	77	30	-	79	35	79	63
7/8" (22.22mm)	88	35	-	92	48	92	96
1" (25.4mm)	102	39	-	103	58	103	112
1-8/16" (28.58mm)	115	45	-	118	55	118	118
1-4/16" (31.75mm)	127	50	-	130	71	130	135

OPTIONAL ACCESSORIES:



Bending Former & Bending Shoe

Bending Former

- 5/8" R=4D
- 3/4" R=4D
- 7/8" R=4D
- 1" R=4D
- 1-1/8" R=4D
- 1-1/4" R=4D
- 1-3/8" R=3.5D
- 1-1/2" R=3.5D

Part Number

- 0299-0045-00000-001
- 0299-0045-00000-002
- 0299-0045-00000-003
- 0299-0045-00000-004
- 0299-0045-00000-005
- 0299-0045-00000-006
- 0299-0045-00000-007
- 0299-0045-00000-008

Bending Shoe

- | | Part Number |
|--------|--------------------|
| 5/8" | 303-01220-004-001 |
| 3/4" | 303-01220-004-002 |
| 7/8" | 303-01220-004-003 |
| 1" | 303-01220-004-004 |
| 1-1/8" | 303-01220-004-005 |
| 1-1/4" | 303-01220-004-006 |
| 1-3/8" | 203-0126-00001-001 |
| 1-1/2" | 203-0126-00001-002 |



Model	DB32
Voltage	110-120V~ 50-60Hz, 220-240V~ 50-60Hz
Power Input	1700W
No Load min ⁻¹	3.5
Max. Capacity	38mm(1-1/2")
Soft Start	With
Dimensions(LxWxH)	630mm x 230mm x 183mm
Net Weight (Machine only)	14kg (30.86 Lbs)

STANDARD ACCESSORIES

- * Tripod x1
- * Velcro Strap x1

MANUAL PIPE THREADER SETS

Sets include everything needed for manual threading of pipes. The manual ratchet assembly includes the reversible ratchet head, extension handle and grip. Large and small range octagon drive adaptors are included. The rugged 17 tooth ratchet only needs 22.5 degrees of swing and can withstand very high torque loads. The ratchet head is as compact as possible for fitting into confined spaces and die heads may be mounted from either side. A number of different types of threads and die head styles are available. All die heads may also be used in our PT600 power threaders as well. All die heads are precision made and have long pipe guides for centering and starting of threads. Die heads are equipped with tempered steel dies which are precision machined for top quality threads according to approved standards. All sets come with six die heads and are packed in a convenient blow-molded case.

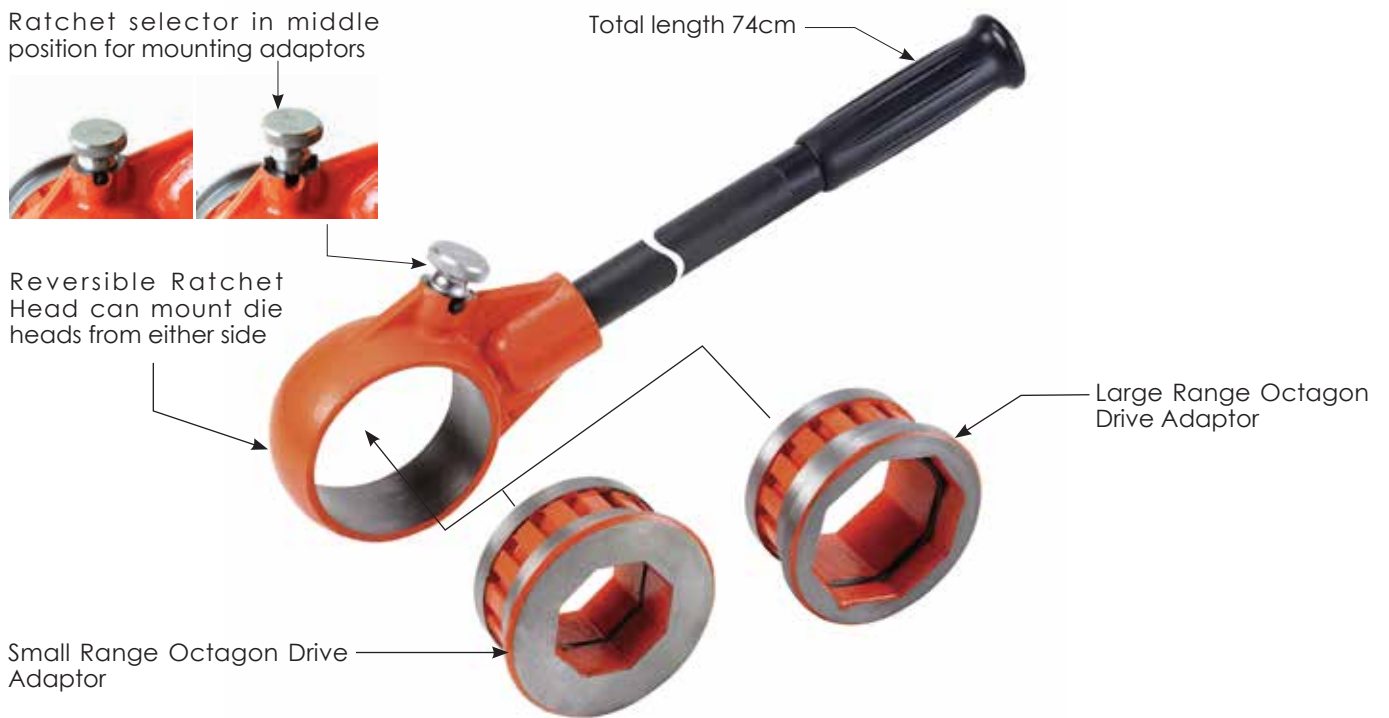

Rothenberger System



Ridgid System

Set Number	Thread Type	Die Type	Sizes
305-03344-149-001	BSPT	Rothenberger System	1/2", 3/4", 1", 1-1/4", 1-1/2", 2"
305-03344-149-002	NPT	Rothenberger System	1/2", 3/4", 1", 1-1/4", 1-1/2", 2"
305-03344-149-003	BSPT	Ridgid System	1/2", 3/4", 1", 1-1/4", 1-1/2", 2"
305-03344-149-004	NPT	Ridgid System	1/2", 3/4", 1", 1-1/4", 1-1/2", 2"

STANDARD ACCESSORIES

N/A

Max. Die Head	2" nominal (60.33mm)
Dimensions(LxWxH)	740mm x 132mm x 57mm (Not Including Adaptor and Die Head)
Net Weight	3.5kg(7.72Lbs) (Not Including Adaptor and Die Head)

PORTABLE THREADING MACHINE

- The powerful solution for fast pipe threading.
- This high-torque machine is very easy to set up and operate. The simple and robust worm gear drive system can thread up to 2 inch pipes.
- Light in weight for ease of handling and compact for fitting in confined spaces. Right and Left-hand threads are cut with equal ease.
- Locking adaptor for small size range die heads included.
- Externally accessible brushes for easy maintenance.
- Machine, Vise, Adapter and set of six die heads all conveniently packed in a sturdy case.

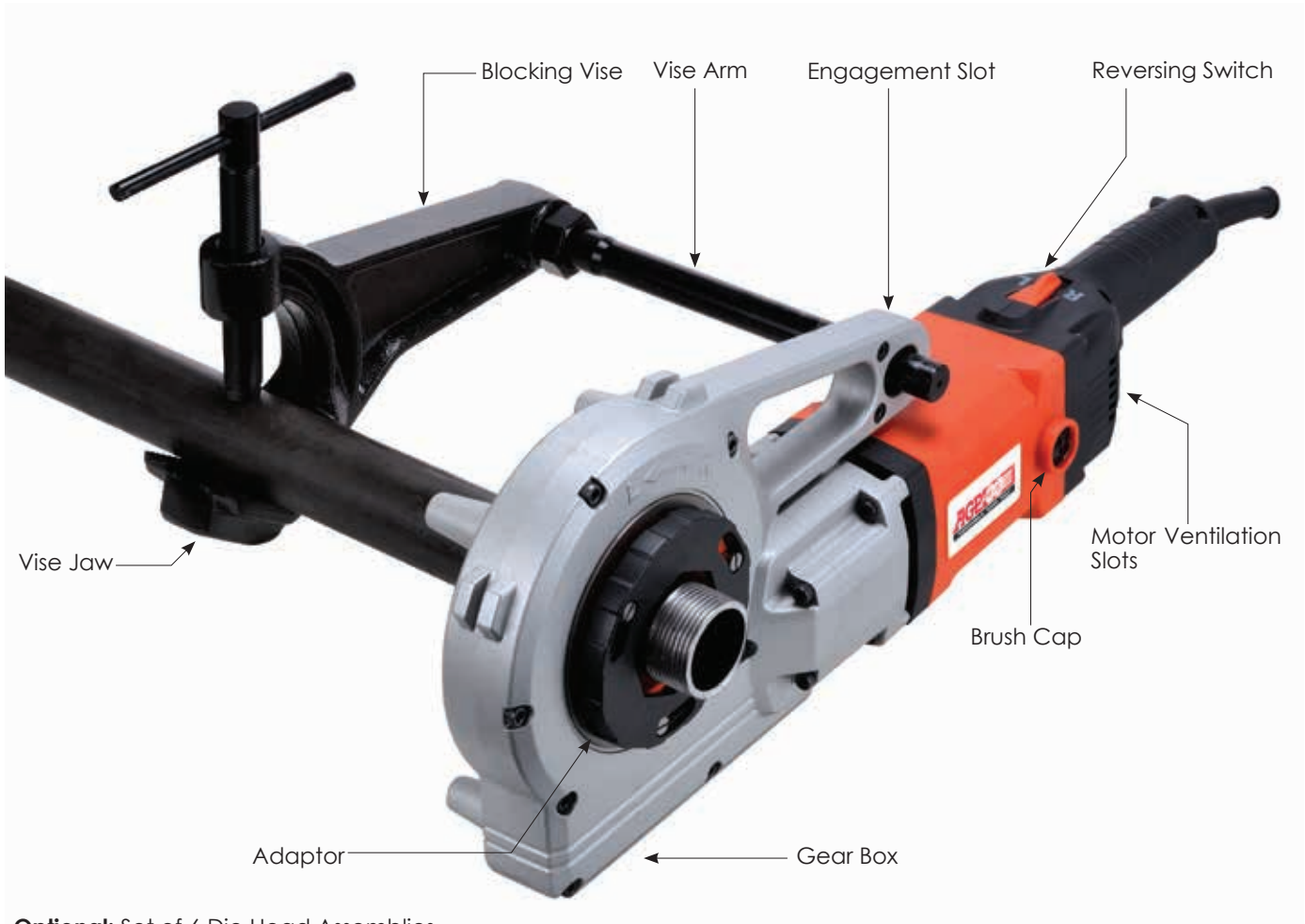

Optional: Set of 6 Die Head Assemblies



Model	PT600
Voltage	110-120V~ 50-60Hz, 220-240V~ 50-60Hz
Power Input	1100 W
No Load min ⁻¹	26
Full Load min ⁻¹	19
Max. Die Head	2" nominal (60.33mm)
Dimensions (LxWxH)	552mm x 200mm x 98mm
Net Weight	7.6kg(16.76Lbs)

STANDARD ACCESSORIES

- * Adaptor x1
- * Blocking Vise x1

OPTIONAL ACCESSORIES

- * Replacement Dies x1
- * Set of 6 Die Head Assemblies: 1/2", 3/4", 1", 1-1/4", 1-1/2" & 2" (Die heads are available in either NPT or BSPT thread forms. Please specify when ordering)

INDIVIDUAL DIE HEADS (Including Dies, Pre-Mounted)

Die Heads are standard octagon drive and fit both PT600 Power Portable Threaders and Manual Pipe Threaders

Set Number	Thread Type	Die Type	Sizes
305-00147-000-002	BSPT	ROTHENBERGER System	1/2"
305-00147-000-003	BSPT	ROTHENBERGER System	3/4"
305-00147-000-004	BSPT	ROTHENBERGER System	1"
305-00147-000-005	BSPT	ROTHENBERGER System	1-1/4"
305-00147-000-006	BSPT	ROTHENBERGER System	1-1/2"
305-00147-000-007	BSPT	ROTHENBERGER System	2"
305-00147-000-008	NPT	ROTHENBERGER System	1/2"
305-00147-000-009	NPT	ROTHENBERGER System	3/4"
305-00147-000-010	NPT	ROTHENBERGER System	1"
305-00147-000-011	NPT	ROTHENBERGER System	1-1/4"
305-00147-000-012	NPT	ROTHENBERGER System	1-1/2"
305-00147-000-013	NPT	ROTHENBERGER System	2"
305-00147-000-014	BSPT	RIDGID System	1/2"
305-00147-000-015	BSPT	RIDGID System	3/4"
305-00147-000-016	BSPT	RIDGID System	1"
305-00147-000-017	BSPT	RIDGID System	1-1/4"
305-00147-000-018	BSPT	RIDGID System	1-1/2"
305-00147-000-019	BSPT	RIDGID System	2"
305-00147-000-020	NPT	RIDGID System	1/2"
305-00147-000-021	NPT	RIDGID System	3/4"
305-00147-000-022	NPT	RIDGID System	1"
305-00147-000-023	NPT	RIDGID System	1-1/4"
305-00147-000-024	NPT	RIDGID System	1-1/2"
305-00147-000-025	NPT	RIDGID System	2"

■ REPLACEMENT DIES (4 pieces per set)

Set Number	Thread Type	Die Type	Sizes
305-00052-000-004	BSPT	ROTHENBERGER System	1/2"
305-00052-000-005	BSPT	ROTHENBERGER System	3/4"
305-00052-000-006	BSPT	ROTHENBERGER System	1"
305-00052-000-007	BSPT	ROTHENBERGER System	1-1/4"
305-00052-000-008	BSPT	ROTHENBERGER System	1-1/2"
305-00052-000-009	BSPT	ROTHENBERGER System	2"
305-00052-000-010	NPT	ROTHENBERGER System	1/2"
305-00052-000-011	NPT	ROTHENBERGER System	3/4"
305-00052-000-012	NPT	ROTHENBERGER System	1"
305-00052-000-013	NPT	ROTHENBERGER System	1-1/4"
305-00052-000-014	NPT	ROTHENBERGER System	1-1/2"
305-00052-000-015	NPT	ROTHENBERGER System	2"
305-00052-000-016	BSPT	RIDGID System	1/2"
305-00052-000-017	BSPT	RIDGID System	3/4"
305-00052-000-018	BSPT	RIDGID System	1"
305-00052-000-019	BSPT	RIDGID System	1-1/4"
305-00052-000-020	BSPT	RIDGID System	1-1/2"
305-00052-000-021	BSPT	RIDGID System	2"
305-00052-000-022	NPT	RIDGID System	1/2"
305-00052-000-023	NPT	RIDGID System	3/4"
305-00052-000-024	NPT	RIDGID System	1"
305-00052-000-025	NPT	RIDGID System	1-1/4"
305-00052-000-026	NPT	RIDGID System	1-1/2"
305-00052-000-027	NPT	RIDGID System	2"

HOLE CUTTING DRILL

Our Hole cutting drill has been designed to quickly drill up to 127mm holes in pipes from 1-1/4" to 8-1/4" diameter. Built-in bubble levels for multiple hole alignment. Tool free quick-release handle can be mounted on either side.

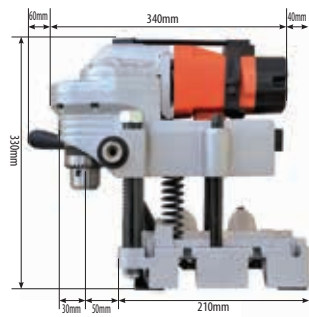

Good balance for Carryir



On/off Switch



The quick adjustable tool-free lever can be mounted on either side.

Hole Cutter (not incl.)



Chain vise clamping system quickly mounts machine onto 1-1/4" to 8-1/4" diameter pipe (32mm-203mm)



Built-in bubble levels for multiple hole alignment



Model	HC127
Power Input	1100W
Voltage	110-120V~ 50-60Hz, 220-240V~ 50-60Hz
No Load min ⁻¹	130
Max. Cutting Capacity (Hole Cutter)	127 mm
Pipe Mounting Capacity	32mm - 203mm (600mm w/ optional Long Chain Set)
Drill Chuck Capacity	1mm-16 mm
Over Load Protection	With
Net Weight	14.5kg (31.9Lbs) Not including Crank Handle

STANDARD ACCESSORIES

- * 16mm(5/8") Chuck & Chuck Key x1
- * Crank Handle Set x1

OPTIONAL ACCESSORIES

- * Long Chain Set x1 (for pipes up to 600mm diameter)

■ TCT Hole Saws (For model HC127) 25mm Depth



Diameter (mm)	Part Number
60	305-03346-000-037
65	305-03346-000-038
70	305-03346-000-039
75	305-03346-000-040
80	305-03346-000-041
85	305-03346-000-042
90	305-03346-000-043
95	305-03346-000-044
100	305-03346-000-045
105	305-03346-000-046
110	305-03346-000-047
115	305-03346-000-048
120	305-03346-000-049
125	305-03346-000-050
127	305-03346-000-051

***Note:** Bi-metal hole saws or twist drills recommended for sizes below 60mm

The **PF8** press fitting machine works with standard press jaws for reliable and effective joining of pipe press fittings. The mechanical press ram with electro-hydraulic control provides even pressure over the entire operation and provides plenty of crimping force to operate all commonly used press jaws up to 40mm and two part jaws up to 110mm. Its unique pressure control design gives it unprecedented service life and eliminates the need for special tools for servicing. For convenience, the ram arm can be rotated to any angle. The built-in LED light makes working in dark spaces easier. The electronic control makes operation simple: Simply hold the trigger, and when the crimping force is reached, the ram automatically returns. If, for whatever reason, the operator wants to abort the operation, simply release the trigger at any time and the ram will automatically return. Truly a practical, durable and easy to use press fit machine.

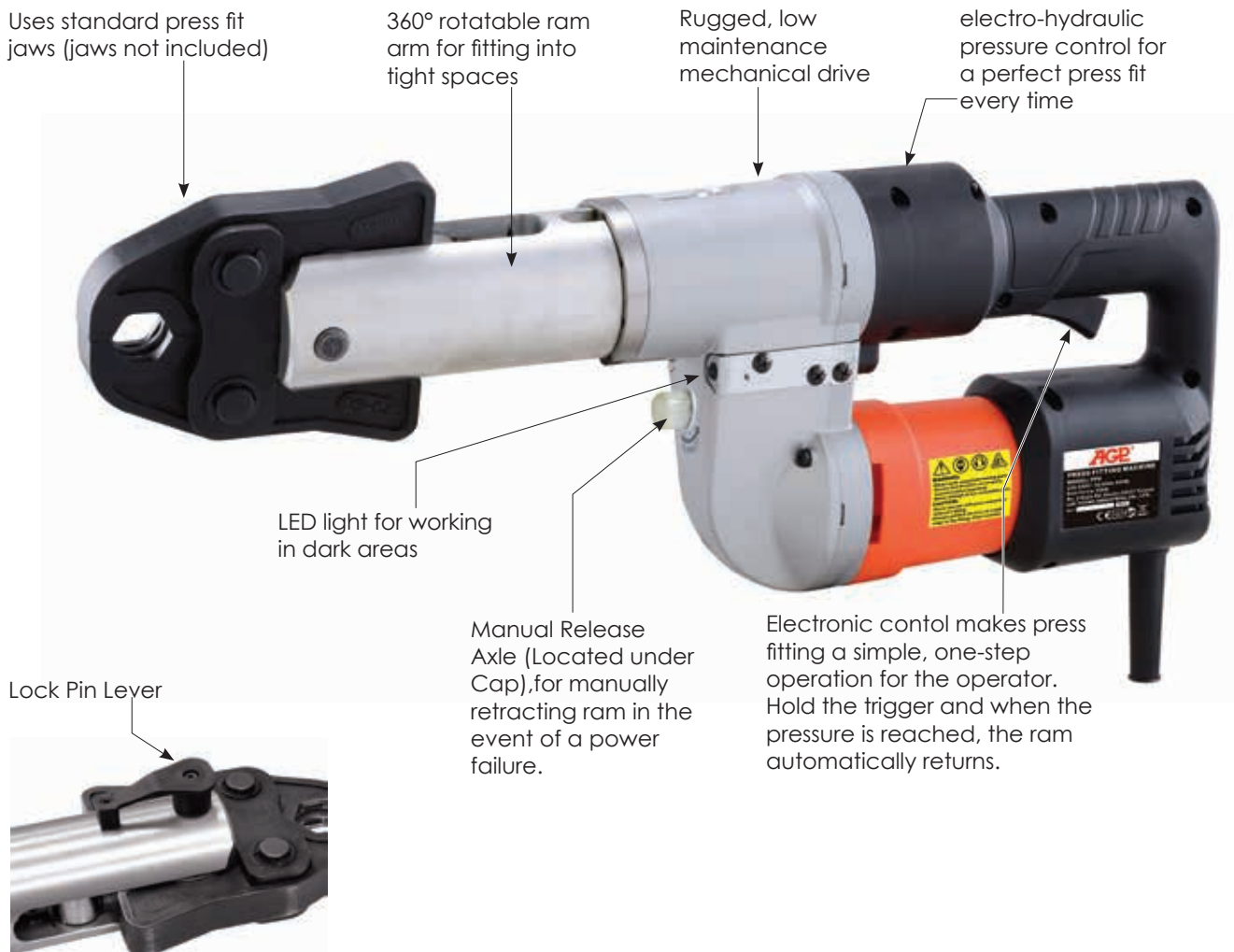

STANDARD ACCESSORIES

N/A

Model	PF8
Power Input	550W
Voltage	110-120V~ 50-60Hz, 220-240~ 50-60Hz
Ram Force (max.)	41kN (limited to 35kN version available)
Max Capacity	10mm - 110mm (40mm with no.2 size jaws)
Dimensions(LxWxH)	450mm x 85mm x 190 mm
Net Weight	5.8kg(12.76Lbs)

DRAIN CLEANING MACHINE

A heavy-duty drain cleaning machine for professional use. This splash-proof machine is safe, neat and easy to use. The Guide hose for ideal spiral control is included as standard. The clutch jaws work for both 16 and 22mm spirals. The powerful 600W output motor is suitable for the most challenging jobs, such as grinding out hard material deposits.

- The AC induction motor offers long life & quiet running .
- Powerful motor up to 600W with high torque , reversible rotation.
- Compact , Handy & Robust for easy Portability and convenience.



Description	Part Number
Funnel Auger 31mm	0202-0071-00903-001
55mm	0202-0071-00903-003
Straight Auger 16mm	0202-0069-00903-001
22mm	0202-0069-00903-002
Bulbous Auger 27mm	0202-0070-00903-001
40mm	0202-0070-00903-002
Forked Cutter	202-0068-00903-001
Carbide Cutter 16mm	202-0067-00903-001

Description	Part Number
Carbide Cutter 22mm	202-0067-00903-002
3 Spiral Cables 16mm x 5m(L)	0202-0072-00907-001
3 Spiral Cables 22mm x 5m(L)	0202-0072-00907-003
Basket	302-04284-903-001
Chuck for 16mm Spiral Cable	302-04283-907-003
Cable Joint Separator	302-04282-903-001
Gloves	305-00152-000-001

Model	D65
Power Input	600W
Voltage	110-120V~ 50-60Hz, 220-240V~ 50-60Hz
No Load min ⁻¹	60Hz: 580 , 50Hz: 480
Dimensions(LxWxH)	353mm x 260mm x 325mm
Net Weight	19.3 kg (42.55 Lbs)

STANDARD ACCESSORIES

- * Basket with 3 Spiral Cables 16mm x 5m(L) or Basket with 3 Spiral Cables 22mm x 5m(L)
- * Funnel Auger 31mm (ø16) or 55mm(ø22) x1
- * Straight Auger 16mm(ø16) or 22mm(ø22) x1
- * Bulbous Auger 27mm(ø16) or 40mm(ø22) x1
- * Forked Cutter x1
- * Carbide Cutter 16mm or Carbide Cutter 22mm x1
- * Chuck for 16 mm Spiral Cable only x1
- * Cable Joint Separator x1
- * Gloves x2
- * Hose 1M x1



RECIPROCATING SAW

The **RS26** brings together all the features you need for a rugged, effective reciprocating saw without the gimmicks. The orbital reciprocating mechanism is specially designed for long term durability and shock resistance. With its pipe vise and straight handle, you will find the RS26 to be an especially effective pipe cutting saw. Or choose the RS130B, the D-handle version, for general tasks

Durable High-Impact Reciprocating Mechanism with Aggressive Orbital Action

Speed Control Thumb Wheel. Electronic Speed Stabilization Circuitry maintains speed under load

Ratchet Handle for quick, tool-free clamping



26mm (1") stroke

Ergonomic Grip with Soft Boot, Aluminum Gear Box for superior durability

Professional Grade Motor with Overload Protection and Soft-Start. Externally accessible Full-Stop Brushes.

Quick-Release Chain Vise (Standard)

■ **A world first** : Optional **2-in-1 vise!** On one side there is a **chain clamp** for 1/2" up to 8" pipes. On the other side is a **Quick-Release Vise**. For pipe cutting, the vise gives 4 times the leverage and a perfect 90 degree cut.



Quick-Release Vise side of the optional 2-in-1 Vise for smaller diameters.



Chain Vise side of the optional 2-in-1 Vise for larger diameters.

■ **Blade (Optional)**



Description
Blade 290mm

Part Number
305-00036-000-033



Model	RS26
Power Input	1500W
Voltage	110-120V~ 50-60Hz, 220-240V~ 50-60Hz
No Load min ⁻¹	1000 - 2100
Stroke	26mm (1")
Max. Capacity	203mm (8")
Soft Start & Overload Protection	With
Dimensions(LxWxH)	491mm x 94mm x 108mm
Net Weight	3.8kg(8.38Lbs)

STANDARD ACCESSORIES

- * Hex. Wrench M4 x1
- * Quick-Release Chain Vise x1

OPTIONAL ACCESSORIES

- * 2-in-1 Vise x1

RECIPROCATING SAW (D-HANDLE)

Durable High-Impact Reciprocating Mechanism

Speed Control Thumb Wheel. Electronic Speed Stabilization Circuitry maintains speed under load

Trigger Switch



Pivoting shoe plate

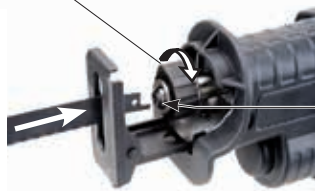

Tool free quick release blade changing system

Shaft

Professional Grade Motor with Overload Protection and Soft-Start. Externally accessible Full-Stop Brushes.

■ Blade (Optional)



Description
Blade 190mm

Part Number
305-00036-000-024



Model	RS130B
Power Input	110-120V:1300W, 220-240V:1600W
Voltage	110-120V~ 50-60Hz , 220-240V~ 50-60Hz
No Load min ⁻¹	1000 - 2800
Stroke	26mm (1")
Max. Capacity	130mm
Speed Control	With
Quick Release Saw Blade Replacing System	With
Soft Start & Overload Protection	With
Dimensions (LxWxH)	470mm x 155mm x 97mm
Net Weight	3.70kg (8.16 Lbs)

STANDARD ACCESSORIES

* Hex. Wrench M6 x1

WET/DRY VACUUM DUST EXTRACTOR

- Purpose-built to work in conjunction with our power tools, the **DE25 Wet / Dry Vacuum Dust Extractor System** has integrated switching for tools up to 2200W. So you don't need to turn the machine on or off manually, just operate the power tool's switch!
- Whether you are using a sander, circular saw, wall chaser, scouring machine or other power tool, the features of the DE25 are designed to fit the needs of professionals.
- Variable suction power allows you to tailor the vacuum to the job at hand. Ideal for our GS9FE, GS9FSE & HS225 Drywall Sanders, DS1600 & DS2300 Plunge-Cut Circular Saws, GP255 & GP255S Miter Saws, SM125 Scouring Machine, BH92 Rotary Bush Hammer, CS125N, CS125, CS150, CS150N & CS180 Wall Chasers, C14, C16 Concrete Saw, EP5LFB, EP5LFBN & EP7FB Stone Grinders, SM5 & SM7 Concrete Grinders, CS320 Metal Cutting Circular Saw, and DMC6D, DMC6P, DM52D & DM52P Diamond Core Drills.
- The tank has an effective capacity of 25 liters and everything is easy to access for quick dumping and filter clearing.
- High-output 1200W motor with enough reserve suction power to work virtually dust-free, even in the most dust-producing power tool applications.
- Long-life motor has bypass cooling to avoid over-heating, even in the most challenging conditions.
- Fully-Automatic Electromagnetic Filter Shaker for convenient, uninterrupted use. At preset intervals, the Filter Shaker Loosens fine particles which would normally clog the filter.
- Powerful Electric Blower function.
- Optional Pneumatic Switching similar to the Integrated Switching above for electric tools, this function works with air tools like sanders.



Model	DE25	DEP25 (Pneumatic Switching Version)
Power Input	1200W	
Voltage	110-120V~ 50-60Hz, 220-240V~ 50-60Hz	
Max. Airflow	4000 l/min (141.3 CFM)	
Max. Suction (lift)	25 kpa (250 mbar, 100.4 inches of water)	
Protection	IP 44	
Max. Dust Capacity	25 L (6.6 gallons)	
Max. Connected Power Tool	2200 W	
Soft Start	With	
Dimensions (LxWxH)	598mm x 408mm x 420mm	
Net Weight	12.9kg (28.44 Lbs)	13.8kg (30.42 Lbs)

STANDARD ACCESSORIES

- * Vacuum Hose (4M) x1
- * Pleated Main Filters (pair) x2
- * Washable Diaphragm Filter x1
- * Cloth Dust Bag with Hook & Loop Closure x1

Integrated Switching: Just pull the trigger of your power tool to automatically switch the vacuum on or off. When shutting off, suction continues for a few seconds to clear the hose of dust.

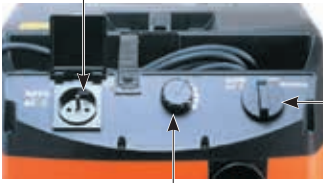

Multi-mode switch For standard switch, power tool integrated switch, or optional air tool integrated switch.

Variable Motor Speed Control. To tailor the suction to various applications and tools.



■ **Pneumatic Switching Model DEP25**

For integrated switching triggered by your air sander.

Remark: Min. Pressure : 3 bar

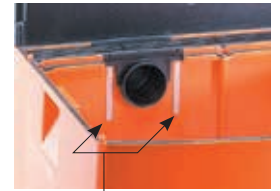

Liquid overflow switch shuts off machine when liquid level gets too high.



Convenient quick-release strap for stowing the hose.

OPTIONAL ACCESSORIES:



Wet Filters x1
(Each machine requires 2 pcs)

Part Number

305-00085-000-001



Pleated Main Filters x1
(Each machine requires 2 pcs)

Part Number

305-00079-000-001



Washable Diaphragm Filter x1
Pull Strap x1

Part Number

0299-0029-00000-001

303-02029-004-001



Paper Dust Bag x1

Part Number

0299-0025-00000-001



Cloth Dust Bag with Hook & Loop Closure x1

299-0026-00000-003



Vacuum Hose (4M) x1

Part Number

0203-0007-00004-004



Vacuum Hose End Adaptor x1

Part Number

303-02026-004-001



1.Handle (32mm) x1

Part Number 305-00307-000-001

2.Crevice Nozzle (32mm) x1

Part Number 305-00307-000-003

3.Floor Nozzle (32mm, Horse Hair) x1

Part Number 305-00307-000-004

4.Round Brush (PP Hair, 32mm) x1

Part Number 305-00307-000-002

5.Chrome Telescopic Tube

(32mm, 48/78cm) x1

Part Number 305-00307-000-005



PLUNGE-CUT CIRCULAR SAW

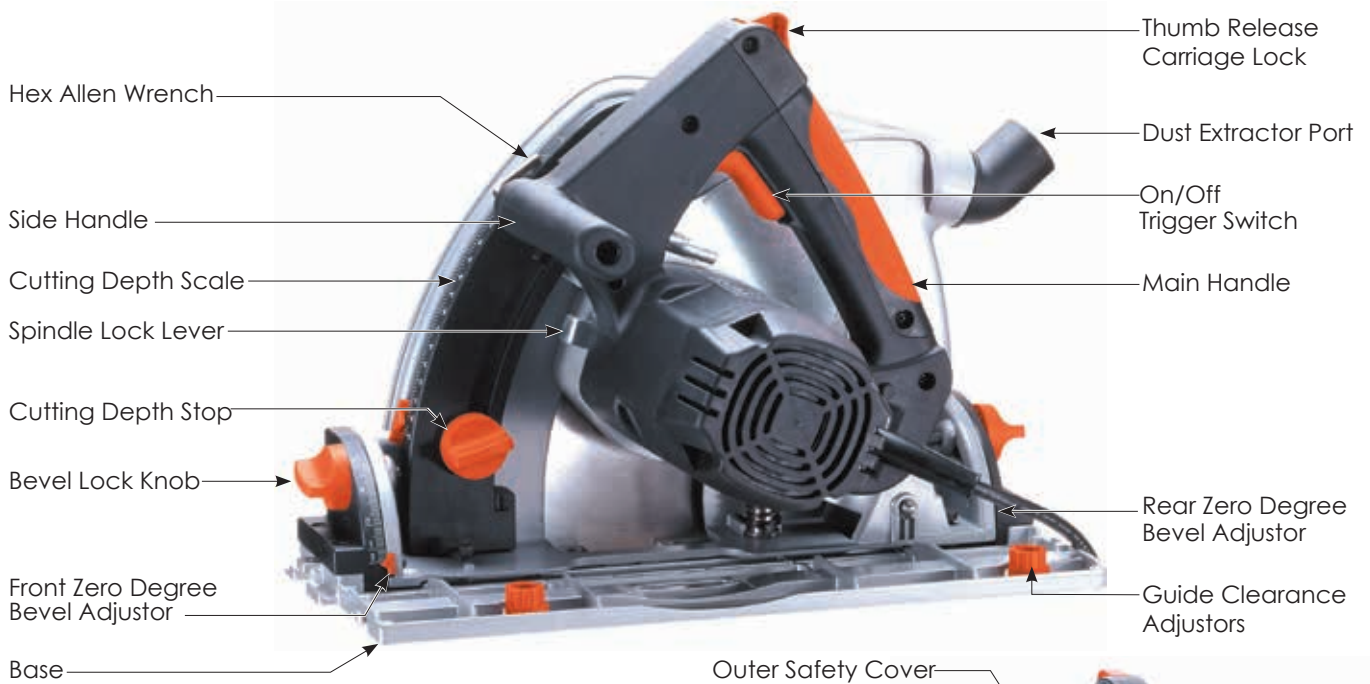

Plastic Carry Case

Outer Dimensions

455mm x 333mm x 375mm(H)
352mm x 257mm x 312mm(H)

Application

DS2300
DS1600

Part Number

0299-0075-00100-010
0299-0075-00100-009

OPTIONAL ACCESSORIES:



The guide rail allows perfectly straight cuts and the cut-to-fit rubber strip shows the operator exactly where the cutting line will be.

Aluminum Guide Rails Spec.

Guide Rail 174mm x 1400mm
Guide Rail 174mm x 800mm



Guide Rail Connector



Lever Clamp

Description

Guide Rail Connector
Lever Clamp

Part Number

0299-0106-00000-001
305-00179-000-001

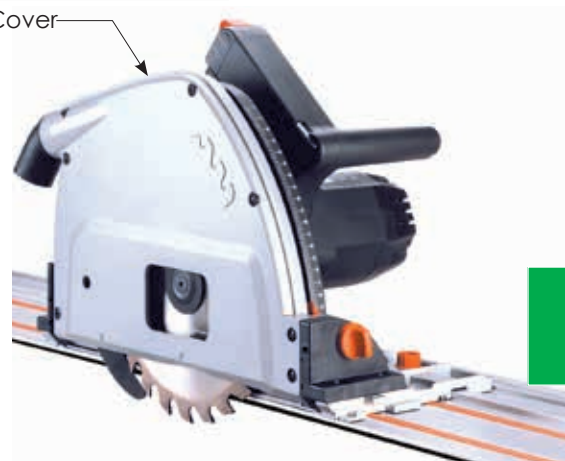

Plastic Carry Case



Model	DS2300	DS1600
Power Input	1600W	1150W
Voltage	110-120V~ 50-60Hz, 220-240V~ 50-60Hz	
No Load min ⁻¹	5000	5500
Bevel Capability	0 - 45 deg.	0 - 45 deg.
Max. Blade Diameter	230mm (9 in.)	160mm (6-1/4 in.)
Available Arbor Hole Diameters*	30mm, 25.4mm (1 in.), 20mm	20mm
Max. cutting Straight	85mm (3-3/8")	55mm (2-3/16 in.)
Depth 45 Deg. Bevel	60mm (2-3/8")	35mm (1-3/4 in.)
Soft Start & Overload Protection	With	With
Dimensions(LxWxH)	428mm x 246mm x 311mm	322mm x 228mm x 266mm
Net Weight	7.7 kg (16.98 Lbs)	4.8 kg (10.58 Lbs)

STANDARD ACCESSORIES

- * Hex. Wrench M5 x1
- * TCT Saw Blade (See P.62)

COMPOUND & SLIDE COMPOUND MITER SAWS

Perfect for both contractors and remodelers, our saws are built tough yet light enough for ease of movement to any job site. Every design detail was considered to maximize rigidity, strength, and reliability while minimizing weight. We use of an AC induction motor instead of the noisy universal type motors with carbon brushes used by the competition. The AC induction motor offers double the service life of a universal type motor, with the added bonus of quieter and smoother operation. We did not forget convenience, either ! Our saws provide 9 positive stops for all the most popular miter angles with fast and easy bevel adjustment. Every feature comes together to provide exact and clean cuts for a variety of materials. Ideal for quick and easy cutting of hardwoods, veneer, fiberboard and plastic, as well as aluminum sash and siding. The optional Mechanical Motor Brake gives solid, reliable stopping within 2-3 seconds. This is much quicker and durable than unreliable electronic motor brakes. The optional double port vacuum extractor provides a virtually dust-free work environment.

Single-phase induction motor for quiet operation and over double the service life of a universal motor

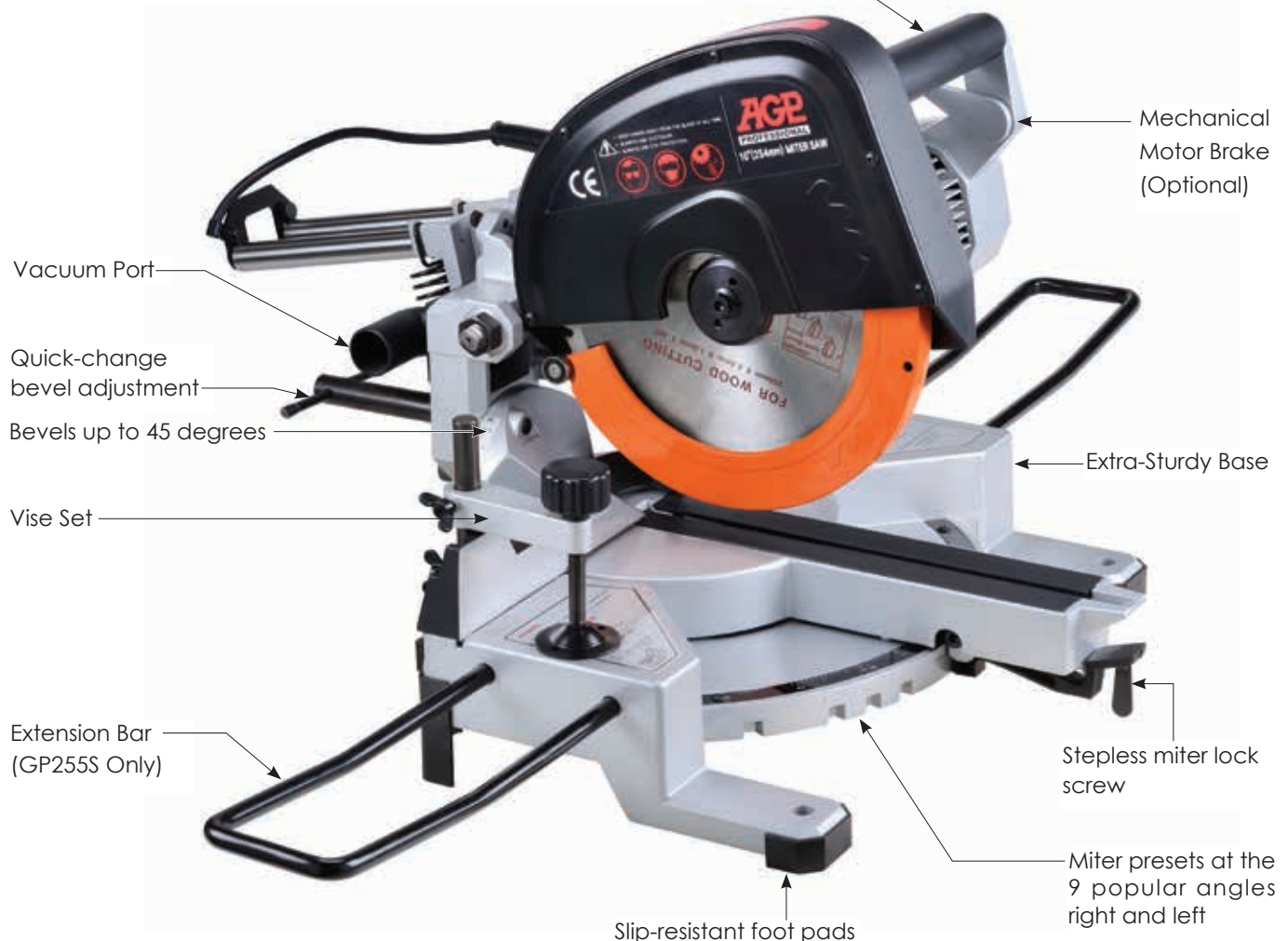



GP255



GP255S

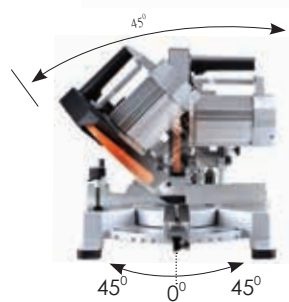
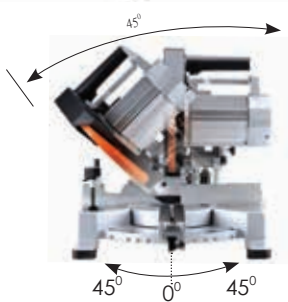

Power Input	1600W	
Voltage	110-120V~ 50-60Hz, 220-240V~ 50-60Hz	
No Load min ⁻¹	3000 (50Hz), 3600 (60Hz)	
Bevels	0 to 45 Degrees	
Miters	0 to 45 Degrees Left and Right	
Blade	254 mm (10 in.)	
Arbor	30mm (1-3/16 in.) or 25.4mm (1 in.)	
Base Dimensions	460 X 450mm	
Slide (GP255S)	Cutting Capacities	90 Degree Miter : 300mm x 60mm (11-13/16 X 2-3/8 in.) 45 Degree Miter : 212 mm x 60mm (8-3/8 X 2-3/8 in.)
	Dimensions (LxWxH)	670mm x 490mm x 505mm
	Net Weight	19.5 kg (43 Lbs)
Non-Slide (GP255)	Cutting Capacities	90 Degree Miter: 100 mm x 60mm (4 X 2-3/8 in.) 45 Degree Miter: 76 mm x 60mm (3 X 2-3/8 in.)
	Dimensions(LxWxH)	564mm x 490mm x 505mm
	Net Weight	18.5 kg (40.79 Lbs)

GP255

STANDARD ACCESSORIES

- * TCT Saw Blade x1
(Bore 30mm Negative Deg. x1
or Bore 25.4mm Positive Deg.) x1
- * Hex. Wrench M6 x1
- * Lock Bar x1
- * M10 Open End Wrench x1
- * M12 Bevel Lock Lever x1
- * M24/27 Open-End Wrench x1
- * Flat Washer x1
- * Vacuum Port x1

GP255S

STANDARD ACCESSORIES

- * TCT Saw Blade x1
(Bore 30mm Negative Deg.
or Bore 25.4mm Positive Deg.)
- * Vise Set x1
- * Motor Brake (Includes Lock Nut
Wrench and Hex. Wrench M6) x1
- * Vacuum Port x1
- * M10 Open End Wrench x1
- * M12 Bevel Lock Lever x1
- * M24/27 Open-End Wrench x1
- * Hex. Head Screw x1
- * Flat Washer x1
- * Plastic Head Screw x1

OPTIONAL ACCESSORIES

- * TCT Saw Blade (See P. 62)
- * Motor Brake (Includes Lock
Nut Wrench and Hex.
Wrench M6) x1
- * Vise Set x1
- * Extension Bar (GP255S Only) x1



Description	Part Number
Extension Bar	302-04218-902-001

TCT SAW BLADES



■ TCT Saw Blades for Wood:

Application	Part Number	Dia. (mm)	Kerf. (mm)	Bore (mm)	Teeth	Plate (mm)	Hardness HRA	Carbide (mm)		Hook Angle	Grind
								Thick	Length		
DS1600	305-00036-000-003	160	2.8	20	28	2	92	2	6.5	0°	ATB
DS2300	305-00036-000-012	230	3.2	30	24	2.2	92	2.3	8	20°	ATB
GP255, GP255S	305-00036-000-016	255	2.6	25.4	40	1.8	92	1.6	5.5	20°	ATB
GP255,GP255S	305-00036-000-017	255	2.8	30	40	1.8	92	1.6	5.5	0°	ATB

■ TCT Saw Blade for Aluminium:

Application	Part Number	Dia. (mm)	Kerf. (mm)	Bore (mm)	Teeth	Plate (mm)	Hardness HRA	Carbide (mm)		Hook Angle	Grind
								Thick	Length		
DRC355	305-00036-000-020	355	2.4	25.4	80	2.0	91	1.9	6.2	0°	TCG
GP255,GP255S	305-00036-000-058	255	2.6	25.4	100	1.8	91	1.6	5.5	0°	TCG
GP255,GP255S	305-00036-000-066	255	2.6	30	100	1.8	91	1.6	5.5	0°	TCG

■ TCT Saw Blades for Steel:

Application	Part Number	Dia. (mm)	Kerf. (mm)	Bore (mm)	Teeth	Plate (mm)	Hardness HRA	Carbide (mm)		Hook Angle	Grind
								Thick	Length		
CS200	305-00036-000-008	203	2.0	20	40	1.6	90.8	1.6	5.5	0°	TCG
CS230N	305-00036-000-029	230	2.0	25.4	48	1.6	90.8	1.6	5.5	0°	TCG
CS320	305-00036-000-054	320	2.2	25.4	80	1.8	90.8	1.9	6.2	0°	TCG
DRC355	305-00036-000-001	355	2.4	25.4	80	2.0	90.8	1.9	6.2	0°	TCG

■ TCT Saw Blades for Stainless Steel:

Application	Part Number	Dia. (mm)	Kerf. (mm)	Bore (mm)	Teeth	Plate (mm)	Hardness HRA	Carbide (mm)		Hook Angle	Grind
								Thick	Length		
CS200	305-00036-000-037	203	1.8	20	52	1.4	90.8	1.6	5.5	7°	TCG
CS230N	305-00036-000-039	230	1.8	25.4	60	1.4	90.8	1.6	5.5	10°	TCG
DRC355	305-00036-000-021	355	2.4	25.4	90	20.	90.8	1.9	6.2	10°	TCG

Note: Tooth Grind Patterns

ATB (Alternate Top Bevel)

Ideal for cross cutting and ripping in wood

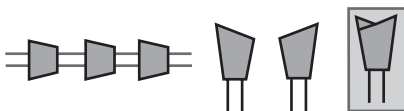

TCG (Triple Chip Grind)

Ideal for metal cutting blades. Gives long sharp life in hard materials.

The pointed tooth cuts narrow kerf, then the flat-top raker tooth widens the kerf and clears out chips.

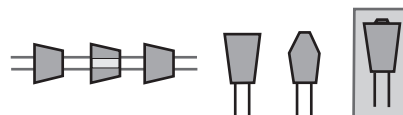

STONE GRINDER

Our Stone grinders are ideal tools for grinding and polishing stone. The machine is light and comfortable to handle. The speed is adjustable by thumb wheel to suit the needs of different materials and the electronic speed stabilization maintains an even speed under all loads. This even working speed is the secret to a superior finish which professionals demand.

NOTE: Models without the "N" suffix (EP5W, EP5L, EP5LF & EP5LFB) are equipped with electronic speed control with speed stabilization which automatically and rigidly maintains even speed and boosts the motor's rated output. Models with the "N" suffix (EP5WN, EP5LN, EP5LFN & EP5LFBN) are equipped with standard-type electronic speed control circuitry. These provide better operator feel but have less ability to maintain even speed.



Part Number

Sanding Pad 305-00063-004-001



Model	EP5W	EP5WN	EP5L	EP5LN
Power Input	1200W			
Voltage	110-120V~ 50-60Hz, 220-240V~ 50-60Hz			
No Load min ⁻¹	3900 - 7300		1700-3700	
Spindle	M14			
Max. Disc Diameter	125 mm			
Soft Start & Overload Protection	With			
Dimensions(LxWxH)	303mm x 72mm x 80mm			
Net Weight	2.0 kg (4.41Lbs)		2.2kg(4.85Lbs)	

STANDARD ACCESSORIES

- * Side Handle x1
- * Inner & Outer Flanges x1
- * Lock Nut Wrench x1

OPTIONAL ACCESSORIES

- * Hook & Loop Backing Plate x1
- * Guard (EP5W only) x1
- * Sanding Pad x1
- * 5" Dust Collector Saw Cover x1

STONE GRINDER



Sanding Pad

Part Number

305-00063-004-001



(EP5LF, EP5LFB ONLY)



Model	EP5LF	EP5LFN	EP5LFB	EP5LFBN
Power Input	1200W			
Voltage	110-120V~ 50-60Hz, 220-240V~ 50-60Hz			
No Load min ⁻¹	2100 - 4300			
Spindle	M14 or 5/8"-11			
Max. Disc Diameter	5" (125mm)			
Soft Start & Overload Protection	With			
Protection Class	Class I with PRCD / GFCI			
Dimensions(LxWxH)	303mm x 72mm x 80mm			
Net Weight	2.57kg (5.67Lbs)		2.8 kg (6.17Lbs)	

STANDARD ACCESSORIES

- * L-Hex Key, M2 x1
- * PRCD / GFCI Interruptor x1
- * Inner & Outer Flanges x1
- * Lock Nut Wrench x1
- * Front Handle x1

OPTIONAL ACCESSORIES

- * Sanding Pad x1

STONE GRINDER



Model	EP7F	EP7FB
Power Input	2200W	
Voltage	110-120V~ 50-60Hz, 220-240V~ 50-60Hz	
No Load min ⁻¹	1000 - 2400 / (Optional : 0 - 4500 also available)	
Spindle	M14 or 5/8"-11	
Max. Disc Diameter	7" (180 mm)	
Soft Start & Overload Protection	With	
Protection Class	Class I with PRCD / GFCI	
Dimensions (LxWxH)	500 mm x 210mm x 200mm	
Net Weight	5.7kg(12.57Lbs)	6.0kg (13.23Lbs)

STANDARD ACCESSORIES

- * Lock Nut Wrench x1
- * PRCD / GFCI Interruptor x1
- * Inner & Outer Flanges x1
- * Front Handle x1

■ EP5 SERIES OPTIONAL ACCESSORIES

5" (125mm) Diamond Cup Wheel x1



#60/80 Grit 22.2mm (7/8")	305-00072-000-018
#100/120 Grit 22.2mm (7/8")	305-00072-000-020

Part Number

■ REPLACEMENT FLANGES



Outer Flange x1 (for both 1" & 7/8")	Thread M14	302-04114-901-004
	5/8"	302-04114-901-010



Inner Flange x1 (2 sided for both 1" & 7/8")	M14	302-04134-903-001
	5/8"	30204134-903-004

Replacement Lock Nut Wrench x1		305-00039-901-001
-----------------------------------	--	-------------------



5" Dust Hood x1	0299-0071-00000-001
-----------------	---------------------



Guard x1	0299-0151-00000-001
----------	---------------------



5" Dust Collector Saw Cover x1

Vacuum port:
38mm O.D.,
32mm I.D.



(A Type)

(A Type) Mounting plate fixes to the cover with pan head screws for extra clearance with grinders with large gear boxes.

Clamping size:	Part Number
36~40mm	0299-0063-00000-010
40~44mm	0299-0063-00000-011
43~47mm	0299-0063-00000-012
48~51mm	0299-0063-00000-013

(B Type) Mounting plate fixes to the cover with tool-free T-Knobs. May cause clearance problems for grinders with large gear boxes. If so, use A Type above.

Clamping size:	
36~40mm	0299-0063-00000-001
40~44mm	0299-0063-00000-002
43~47mm	0299-0063-00000-003
48~51mm	0299-0063-00000-004



(B Type)

(For 9" covers, please see p.30)

■ EP7 SERIES OPTIONAL ACCESSORIES

Diamond Cup Wheel for Flanges 22.2mm(7/8") x1	305-00072-000-011
--	-------------------

Diamond Cup Wheel for Flanges 25.4mm (1") x1	305-00072-000-013
---	-------------------



Diamond Cup Wheel with Female Thread M14 x1	305-00072-000-012
--	-------------------



7" Dust Hood x1	0299-0071-00000-002
-----------------	---------------------



Face Spanner Wrench x1





Face Spanner Wrench-93mm x1 (for diamond plates with female thread)	302-04179-901-001
---	-------------------

Face Spanner Wrench-78mm x1	302-04179-901-002
-----------------------------	-------------------

Remark: 78mm Face Spanner Wrench for
5" Aluminum Pad & 5" Diamond Cup Wheel

■ REPLACEMENT FLANGES

	Outer Flange x1 22.2mm(7/8")	Thread M14 5/8"	Part Number 302-04114-901-002 302-04114-901-007
---	---------------------------------	------------------------------	--

	Outer Flange x1 25.4mm (1")	M14 5/8"	302-04114-901-003 302-04114-901-008
---	--------------------------------	-------------	--

	Inner Flange x1 (for both 1" & 7/8")	M14 5/8"	302-04152-901-001 302-04152-901-004
---	--	-------------	--

■ EP5 & EP7 SERIES SHARED OPTIONAL ACCESSORIES

5" Hook and Loop Aluminum Plate for Diamond Polishing

Aluminum Pad x1	M14	201-0045-00906-001
-----------------	-----	--------------------

Remark: Only 5" Plate is available.



WET TILE SAW

The **TS9** is a wet tile saw for professional use. It uses continuous rim diamond blades. The unique water circulation design minimizes water loss and spillage while the water tray is easy to mount and refill. The dimensionally stable table allows accurate cutting and the parallel cutting guide with the angle guide plate allow precise guidance of the work piece. The table is tool free for quick removal for easy clean-up. The sturdy motor mount system allows the motor to tilt up to 45 degrees for accurate miter cuts. The AC induction motor is quiet, water resistant and long-lasting. It operates at a very stable speed for excellent cutting performance under all circumstances. It's the perfect high precision saw for a professional's needs.

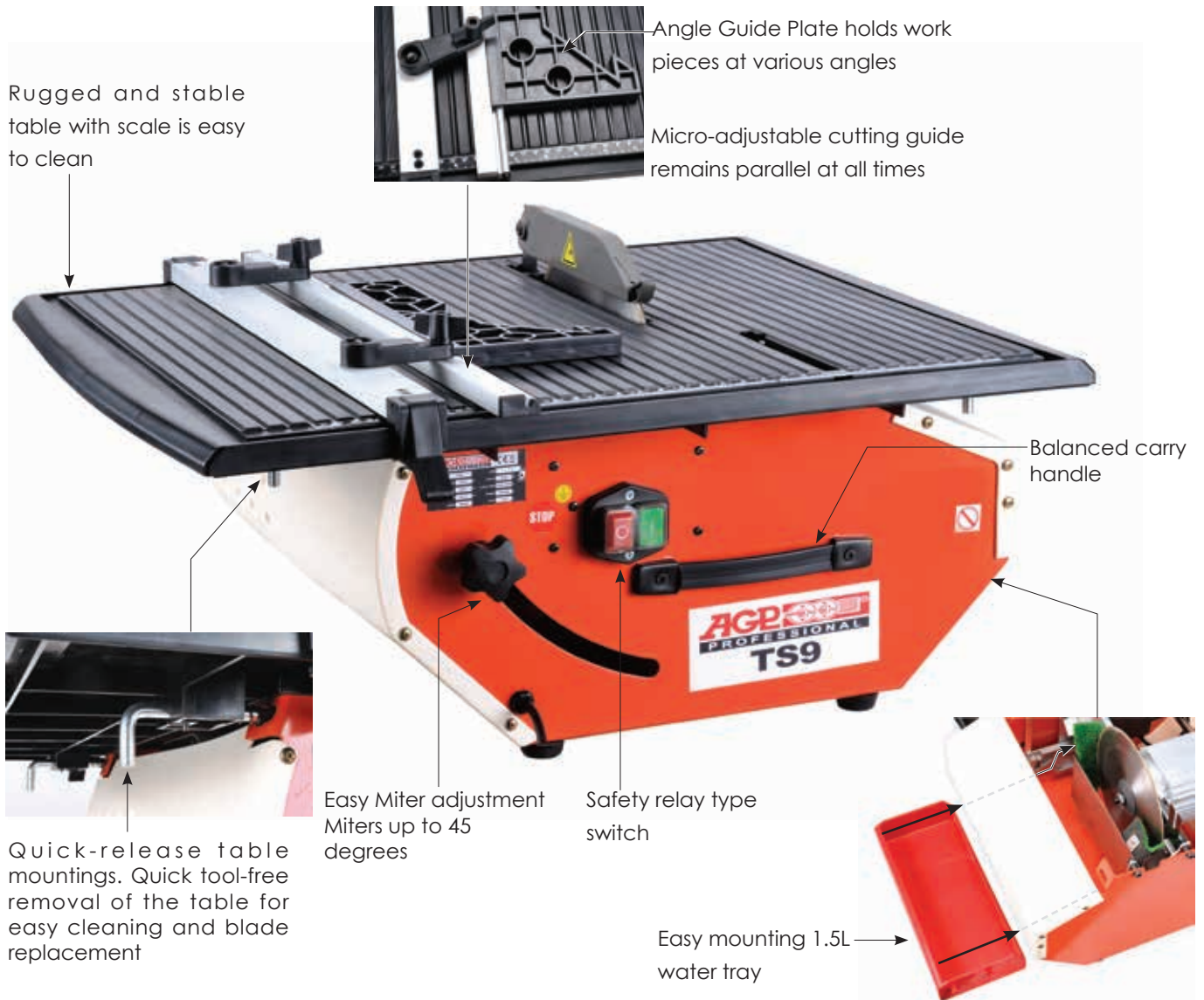

CECB

Model	TS9
Motor Type	Single Phase AC Induction
Power Output	800W
Voltage	110-120V~ 50-60Hz, 220-240V~ 50-60Hz
No Load/min-1	3000 (50Hz), 3600 (60Hz)
Max. Blade Diameter	230mm (9")
Blade Bore	25.4mm (1")
Bevel Capability	0-45 deg.
Max. Cutting Depth-straight	48mm (1-7/8")
Max. Cutting Depth- at 45 deg.	37mm (1-7/16")
Table Cutting Width -Left	305mm (12")
Table Cutting Width -Right	147mm (5-3/4")
Protection	IP44
Dimensions(LxWxH)	660mm x 595mm x 320mm
Weight	14.7kg (32.41 Lbs)

STANDARD ACCESSORIES

- * Diamond Blade x1
- * Parallel Cutting Guide x1
- * Angle Guide Plate x1
- * M8 Combination Wrench x1
- * M19 Combination Wrench x1

WALL CHASER

The **CS125, CS125N, CS150, CS150N** Wall Chaser is a light, easy-to-handle machine. The blades run clockwise so it's very convenient for vertical chases, just pull the machine downwards along the wall. The dust control is excellent for healthy, mess-free operation. The powerful motor with electronic speed stabilization circuitry allows the machine to maintain the same speed, without slowing, regardless of load.

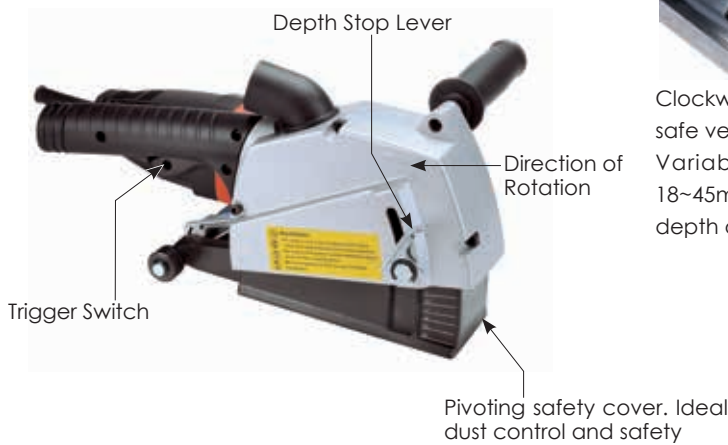
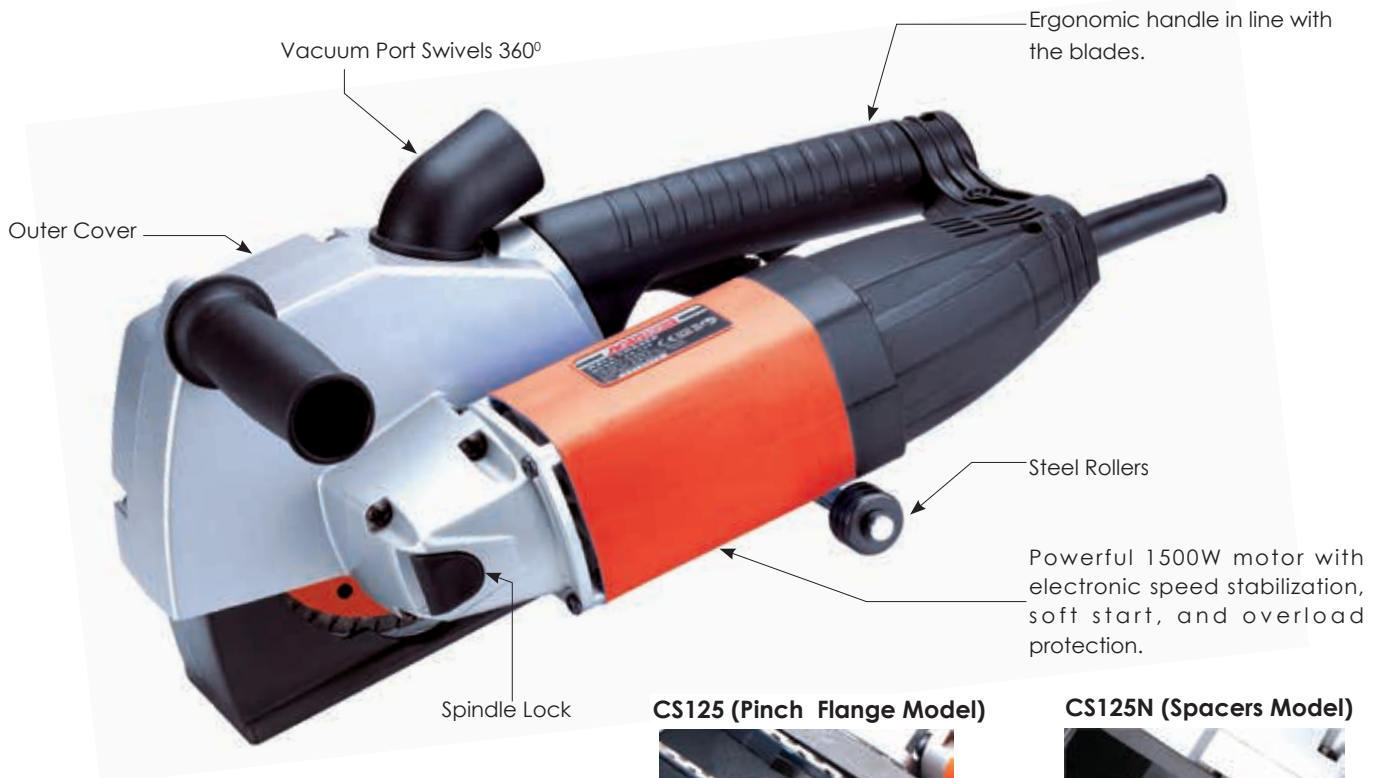

CS125 (Pinch Flange Model)



Clockwise blade rotation for safe vertical chasing. Variable width of blades. 18~45mm. Maximum cutting depth of 45mm.

CS125N (Spacers Model)

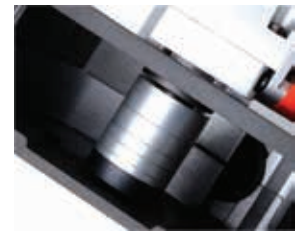

Spacers



Place as many spacers as necessary to achieve the desired groove width. They are in sizes:
 40mm x 22.2mm x 6mm (2 pcs)
 40mm x 22.2mm x 4mm (1 pcs)
 40mm x 22.2mm x 10mm (1 pcs)
 40mm x 22.2mm x 15mm (1 pcs)



Model	CS125 (Pinch Flange Model)	CS125N (Spacers Model)
Power Input	1500W	
Voltage	110-120V~ 50-60Hz, 220-240V~ 50-60Hz	
No Load min ⁻¹	6500	
Bore	22.2 or 30mm	
Soft Start & Overload Protection	With	
Max. Blade Diameter	125mm	
Blade Bore Size	22.23mm (7/8")	
Max. cutting depth	30mm	
Dimensions(LxWxH)	378mm x 221mm x 196mm	
Channel Width	18-45mm	8-45mm
Net Weight	4.4kg(9.7Lbs)	4.4kg(9.7Lbs)

STANDARD ACCESSORIES

- * Side Handle x1
- * 4mm T-Handle Hex Wrench x1
- * Vacuum Hose End Adaptor x1
- * 8mm L-Hex Wrench (CS125 only) x1
- * 40mm Open End Wrench (CS125 only) x1
- * 6mm L-Hex Wrench (CS125N only) x1
- * Spacers (CS125N only) x1

OPTIONAL ACCESSORIES

- *125mm Diamond Blade x1

WALL CHASER



CS150 (Pinch Flange Model)



Clockwise blade rotation for safe vertical chasing. Variable width of blades. 18~45mm. Maximum cutting depth of 45mm.

CS150N (Spacers Model)

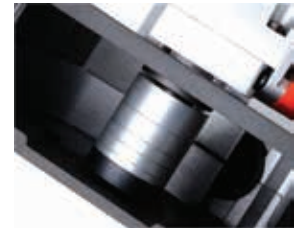

Spacers



Place as many spacers as necessary to achieve the desired groove width. They are in sizes:
 40mm x 22.2mm x 6mm (2 pcs)
 40mm x 22.2mm x 4mm (1 pcs)
 40mm x 22.2mm x 10mm (1 pcs)
 40mm x 22.2mm x 15mm (1 pcs)

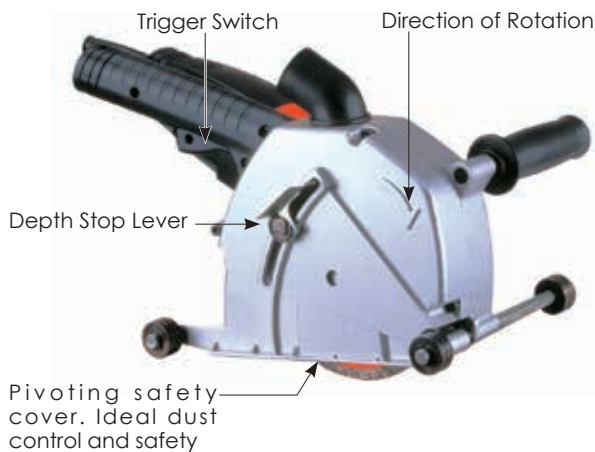

Model	CS150 (Pinch Flange Model)	CS150N (Spacers Model)
Power Input	1500W	
Voltage	110-120V~ 50-60Hz, 220-240V~ 50-60Hz	
No Load min ⁻¹	6500	
Max. Blade Diameter	150mm	
Blade Bore Size	22.23mm (7/8")	
Channel Width	18~45mm	8~45mm
Max. Cutting Depth	45mm	
Soft Start & Overload Protection	With	
Dimensions(LxWxH)	221 mm x 353mm x295mm	
Net Weight	4.8kg(10.58Lbs)	4.8kg(10.58Lbs)

STANDARD ACCESSORIES

- * Side Handle x1
- * 4mm T-Handle Hex Wrench x1
- * Vacuum Hose End Adaptor x1
- * Hex. Wrench M8 (CS150 only) x1
- * 40mm Open-End Wrench (CS150 only)x1
- * 6mm T-Handle Hex Wrench (CS150N only)x1
- * Spacers (CS150N only) x1

OPTIONAL ACCESSORIES

- * 150mm Diamond Blade x1

WALL CHASER

- Equipped with a powerful 1800 Watt motor to run the two 180mm diamond blades with no bogging. The motor is protected by a smart electronic overload (No thermal switch to wait for: just release the switch and start again.)
- The ergonomic handles allow a variety of holding positions for comfortable cutting.
- The roller base allows smooth action and precise control.
- Various spacers to create channels up to 51mm in width and to a depth of up to 52mm.



Spacers



Place as many spacers as necessary to achieve the desired groove width. They are in sizes 15, 12, 10 and 2 x 5mm.

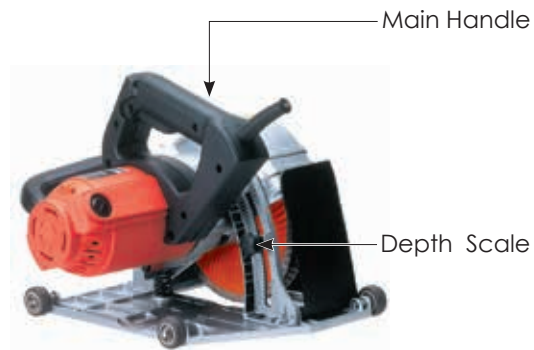

OPTIONAL ACCESSORIES:

■ Wall Chaser Diamond Blades (each machine requires 2 pcs)

Part Number	Diameter	Thickness	Arbor
305-00036-000-007	180mm (7")	1.6mm	22.23mm (7/8")

■ Plastic Carry Case

Part Number	Outer Dimensions
0299-0075-00100-012	455mm x 333mm x 375mm



Vacuum Hose End Adaptor

Plastic Carry Case



Model	CS180
Power Input	1800W
Voltage	110-120V~ 50-60Hz, 220-240V~ 50-60Hz
No Load min ⁻¹	4100
Max. Blade Diameter	180mm (7 in.)
Channel Width	9~51mm (3/8 ~ 2 in.)
Max. Cutting Depth	15~52mm (9/16 ~ 2-3/64 in.)
Soft Start & Overload Protection	With
Dimensions(LxWxH)	410mm x 317mm x 267mm
Net weight	7.7 kg (16.92 Lbs)

STANDARD ACCESSORIES

- * Side handle x1
- * Hex. Wrench M10 x1
- * Vacuum Hose End Adaptor x1
- * Spacers:
 - 49.6mm x 22.2mm x 5mm x2
 - 49.6mm x 22.2mm x 10mm x1
 - 49.6mm x 22.2mm x 12mm x1
 - 49.6mm x 22.2mm x 15mm x1

STONE CUTTING CIRCULAR SAW

The **SCS7** Stone Cutting Circular Saw is the perfect solution for fast, precise wet cutting of all kinds of stone and masonry materials up to 55mm thick. The heart of this machine is its powerful 1800W motor. The parallel guide ensures straight cuts. The water feed with quick-release coupling allows faster cutting and longer blade life. There is a closable vacuum port, which can be used with a wet/dry vacuum to keep the whole job as mess-free as possible. Besides cutting stone, this machine is ideal for cutting out old seams in preparation for replacement. Guide rail allows perfectly straight cuts.



■ Aluminum Guide Rails



The guide rail allows perfectly straight cuts and the cut-to-fit rubber strip shows the operator exactly where the cutting line will be.



Guide Rail Connector



Lever Clamp

Description

Guide Rail Connector
Lever Clamp

Part Number

0299-0106-00000-001
305-00179-000-001



Plastic Carry Case
455mm x 333mm x 375mm

Part Number
0299-0075-00100-012

Spec.
174mm x 1400mm
174mm x 800mm

Model	SCS7
Power Input	1800W
Voltage	110-120V~ 50-60Hz, 220-240V~ 50-60Hz
No Load min ⁻¹	5800
Arbor	22.23mm (7/8")
Max. Blade Diameter	180mm
Max. Cutting Depth	55mm
Overload Protection	With
Protection Class	Class I with PRCD / GFCI
Dimensions(LxWxH)	350mm x 270mm x 265mm
Net Weight	6.7 kg (14.74Lbs)



STANDARD ACCESSORIES

- * Rubber Plug x1
- * Parallel Guide x1
- * Quick-release Water Hose Coupling x1
- * M6 L-Hex Wrench x1
- * PRCD / GFCI Interruptor x1

OPTIONAL ACCESSORIES

- * 7" Diamond Blade x1

CONCRETE SAW

The **C14** is a hand-held saw for concrete, masonry and stone. The 2800W motor offers plenty of power for fast cutting performance and has full electronic overload and thermal protection. The balanced, chainsaw style handles allow maximum control and ideal visibility of the cut. The detachable guide rollers make it easy to keep the blade perfectly square to the cut. The integrated water feed system allows fine tuning of the water supply. For water containment there is a spring-loaded splash guard and a unique brush at the rear of the blade guard which is quick-removable for easy cleaning. It is designed for wet cutting, but is also perfectly suitable for dry cutting. There is a vacuum port which can be used either for wet slurry collection or for dry dust collection. Or use the optional Dust Skid for the ultimate in dry dust control with no sacrifice of cutting depth. Magnesium alloy is used for the blade guard, gear plate and gear box for maximum strength and minimal weight. The blade guard includes locking tool-free adjustment. Truly a versatile and powerful concrete saw for a wide range of applications.

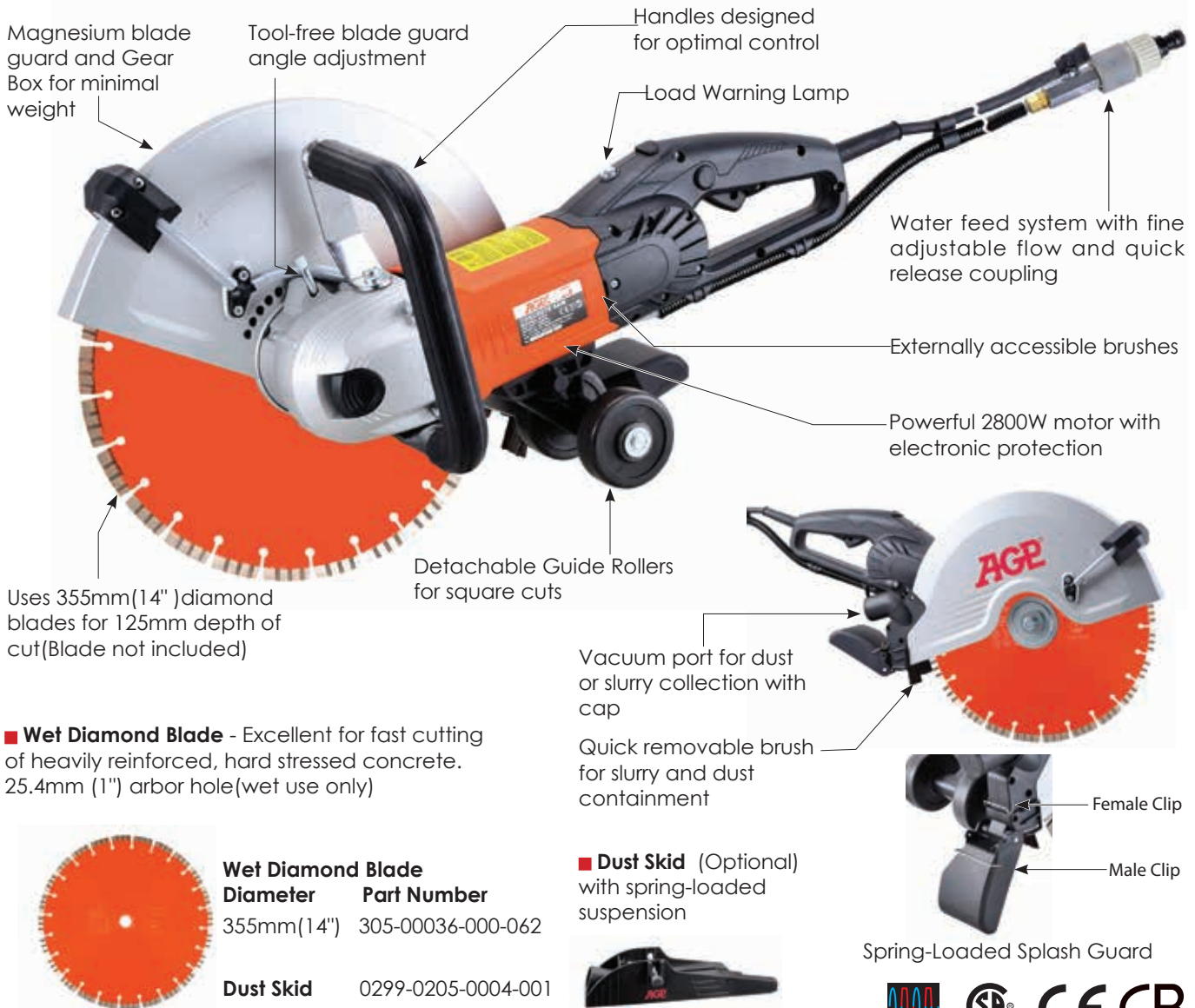

Magnesium blade guard and Gear Box for minimal weight

Tool-free blade guard angle adjustment

Handles designed for optimal control

Load Warning Lamp

Water feed system with fine adjustable flow and quick release coupling

Externally accessible brushes

Powerful 2800W motor with electronic protection

Detachable Guide Rollers for square cuts

Uses 355mm(14") diamond blades for 125mm depth of cut(Blade not included)

■ **Wet Diamond Blade** - Excellent for fast cutting of heavily reinforced, hard stressed concrete. 25.4mm (1") arbor hole(wet use only)

Vacuum port for dust or slurry collection with cap

Quick removable brush for slurry and dust containment

Female Clip

Male Clip

■ **Dust Skid** (Optional) with spring-loaded suspension

Spring-Loaded Splash Guard

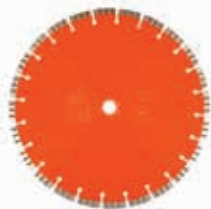

Wet Diamond Blade
Diameter **Part Number**
 355mm(14") 305-00036-000-062

Dust Skid 0299-0205-0004-001



STANDARD ACCESSORIES

- * M17 Combination Wrench x1
- * Guide Roller Set x1
- * Splash Guard Unit x1
- * Blade Guard Brush x1
- * PRCD / GFCI Interruptor x1

OPTIONAL ACCESSORIES

- * Diamond Blade x1
- * Dust Skid x1

Model	C14
Power Input	110V: 1700W, 220V: 2800W
Voltage	110-120V~ 50-60Hz, 220-240V~ 50-60Hz
No Load/min-1	4500
Blade Diameter	355mm (14")
Arbor	25.4mm (1")
Max. Cutting Depth	125mm (5")
Protection Class	Class I with PRCD / GFCI
Dimensions(LxWxH)	625mm x 250mm x 365mm
Weight	7.9kg (17.42 Lbs) (8.3kg (18.3 Lbs) with guide rollers)

CONCRETE SAW

The C16 is a 16" hand-held saw for concrete, masonry and stone. The 3200W motor offers plenty of power for fast cutting performance and has full electronic overload and thermal protection. The 405mm blade gives a full 150mm of cutting depth. The balanced, chainsaw style handles allow maximum control and ideal visibility of the cut. The detachable guide rollers make it easy to keep the blade perfectly square to the cut. The integrated water feed system allows fine tuning of the water supply. For water containment there is a spring-loaded splash guard and a unique brush at the rear of the blade guard which is quick-removable for easy cleaning. It is designed for wet cutting, but is also perfectly suitable for dry cutting. There is a vacuum port which can be used either for wet slurry collection or for dry dust collection. Magnesium alloy is used for the blade guard, gear plate and gear box for maximum strength and minimal weight. The blade guard includes locking tool-free adjustment. Truly a versatile and powerful concrete saw for a wide range of applications.

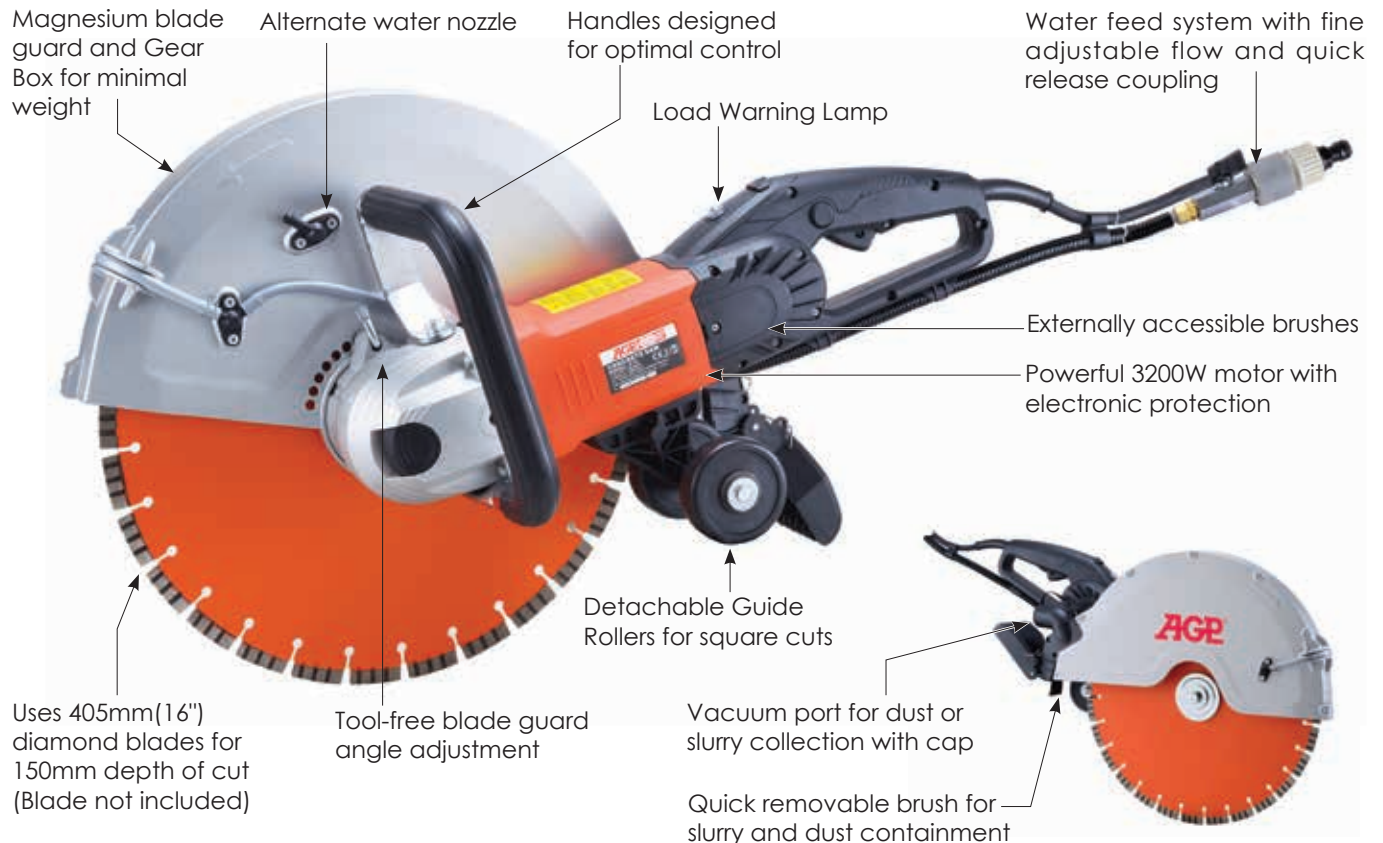

■ **Wet Diamond Blade** - Excellent for fast cutting of heavily reinforced, hard stressed concrete. 25.4mm (1") arbor hole (wet use only)

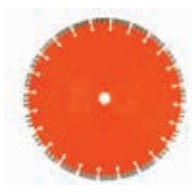

Diameter 405mm(16")
Part Number 305-00036-000-063

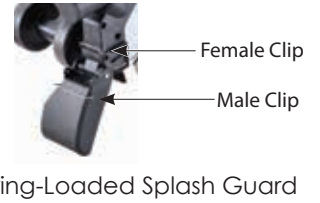

Spring-Loaded Splash Guard



STANDARD ACCESSORIES

- * M17 Combination Wrench x1
- * Guide Roller Set x1
- * Splash Guard Unit x1
- * Blade Guard Brush x1
- * PRCD / GFCI Interruptor x1 (220V models only)

OPTIONAL ACCESSORIES

- * Diamond Blade x1

Model	C16
Power Input	110V: 2300W (certificate), 3000W (actual) 220V: 2700W (certificate), 3200W (actual)
Voltage	110-120V~ 50-60Hz, 220-240V~ 50-60Hz
No Load/min-1	3600
Blade Diameter	405mm (16")
Arbor	25.4mm (1")
Max. Cutting Depth	150mm (6")
Protection Class	Class II, (220V models with PRCD / GFCI)
Dimensions(LxWxH)	735mm x 259mm x 364mm
Weight	9.1kg (20.0 Lbs), (9.6kg (21.1 Lbs) with guide rollers)

HIGH FREQUENCY INTEGRATED CONCRETE VIBRATOR

A very high performance and durable high frequency concrete vibrator with integrated converter for the fastest possible concrete compaction. Excellent for challenging situations like moving a stiff mix into corners and around rebar. The high frequency motor mounted directly in the vibrator head provides extremely consistent vibration. We use a 400Hz motor, which is much more efficient than competitors' 200 Hz designs. There is no need for a separate converter - just plug directly into the outlet. Available in long and short hose lengths giving maximum versatility. The integrated converter has special electronics which allow the same unit to be used with either 110 or 220V supply. Sophisticated converter electronics protect the motor from overload and also protect from over or under voltage input. The extra long cable makes it convenient around the jobsite.

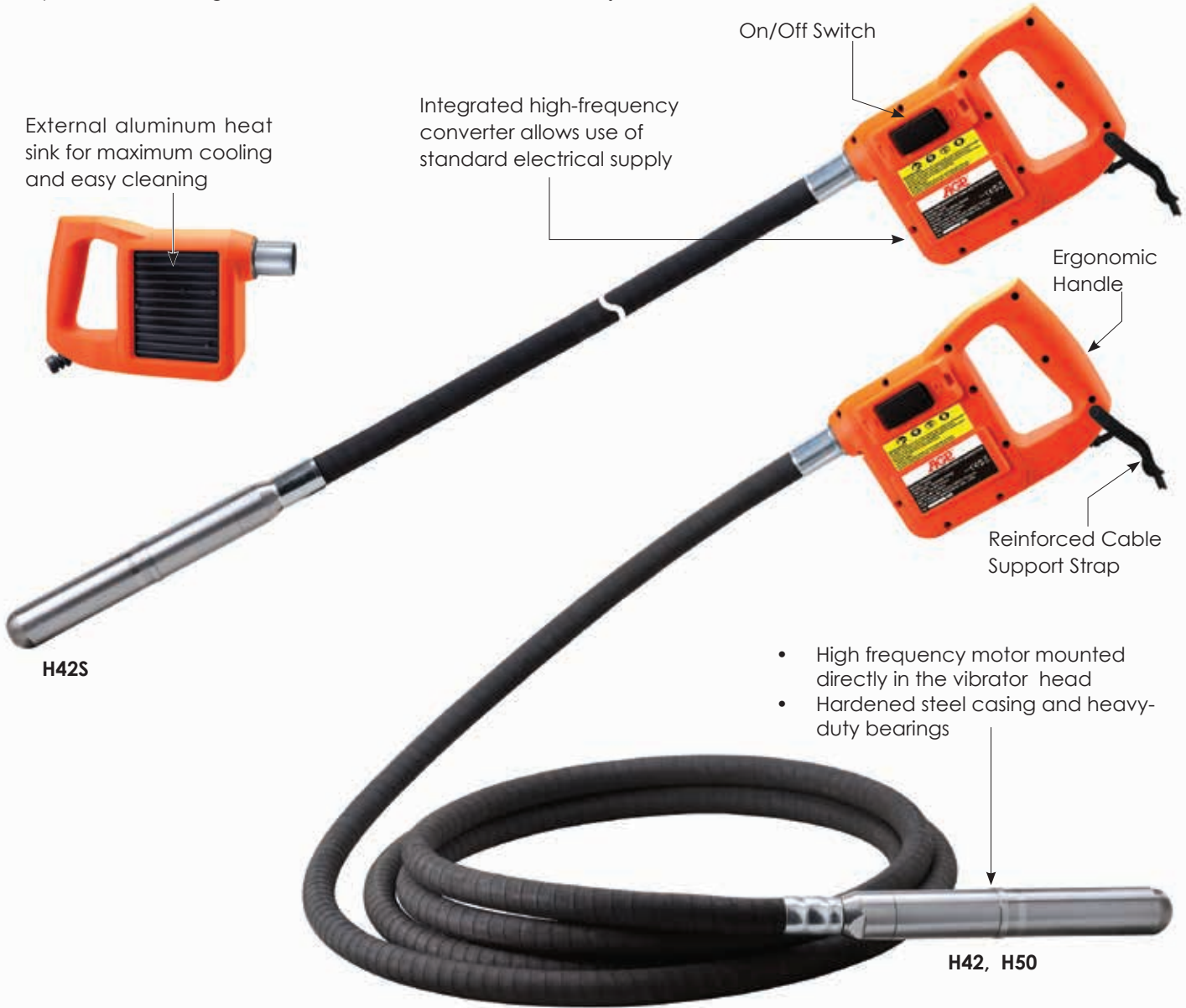

Model	H42S	H42	H50
Voltage	100-250V~ 50-60Hz		
Vibration Rate	12,500 vpm		
Power Output	500W		
Motor Frequency	400Hz		
Centrifugal Force	1814N	1814N	N3347N
Vibrator Head Size	ø42mm x 300mm	ø42mm x 300mm	ø50mm x 305mm
Hose Size	ø36mm x 0.85m	ø36mm x 6m	ø36mm x 6m
Protection	IP X7		
Protection Class	Class I		
Switch box Dimensions(LxWxH)	250mm x 60mm x 170mm		
Net Weight	5.17kg(11.37Lbs)	10.05kg(22.11Lbs)	11.47kg(25.23Lbs)



STANDARD ACCESSORIES
N/A

OPTIONAL ACCESSORIES
* Custom hose lengths available according to customer request

HIGH FREQUENCY CONCRETE VIBRATOR SYSTEM

A very high performance and durable high frequency concrete vibrator system for the fastest possible concrete compaction. Excellent for challenging situations like moving a stiff mix into corners and around rebar. The high frequency motor mounted directly in the vibrator head provides extremely consistent vibration and the extended length gives maximum versatility. The speed is variable to suit work conditions. The converter has special electronics which allow the same unit to be used with either 110 or 220V supply. The extra long cable makes it convenient around the jobsite and the converter has a protective frame.



Vibrator Unit		
Model	V42	V50
Voltage	42V	42V
Vibration Rate	12,000 - 14,500 vpm	12,000 - 14,500 vpm
Power Output	260W	400W
Centrifugal Force	1650~2150 N	2250~3300 N
Vibrator Head Size	ø42 x 300mm	ø50 x 305mm
Hose Size	ø36mm x 6m	ø36mm x 6m
Net Weight	11 kg (24.25Lbs)	12kg (26.46Lbs)

STANDARD ACCESSORIES
N/A

Converter	
Model	P1000
Voltage	90-240V 50/60Hz
Input	1.0 KVA
Output	550W, 42V, 240Hz
Dimensions(LxWxH)	330mm x 210mm x 250mm
Net Weight	5 kg(11.02 Lbs)

CONCRETE VIBRATOR

This light and dependable vibrator is set up to consolidate poured concrete. Comfortable for the operator with the support strap, it's easy to use quickly under all conditions.

The durable, cable-driven vibrator heads and kink resistant shafts are designed to stand up to the rigors of long duty and tough jobsite use.

Various shaft lengths and head diameters are available to suit specific needs.

Convenient and self-contained, these are the best choice for consolidation jobs where easy mobility is needed.

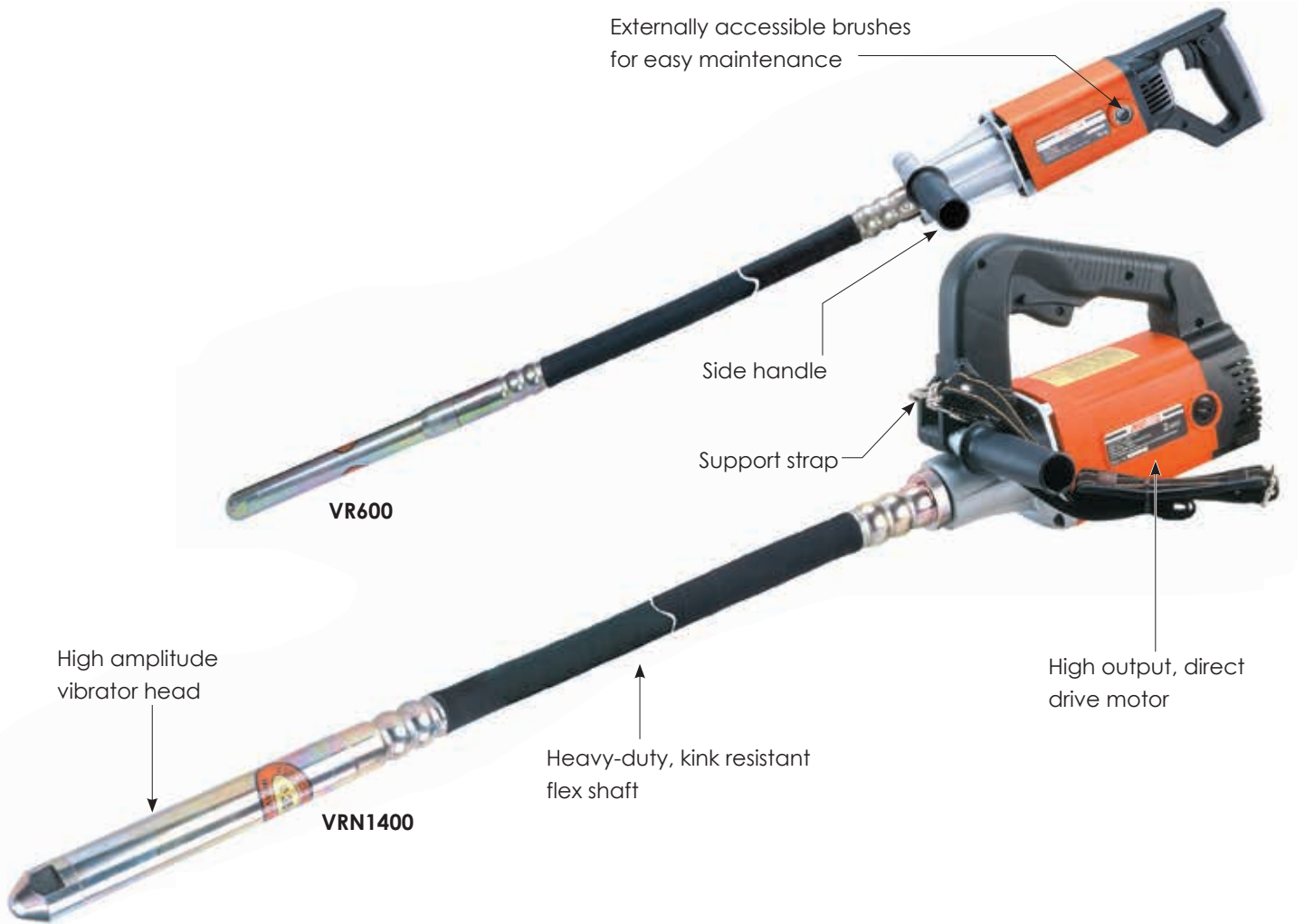

OPTIONAL ACCESSORIES:

■ Concrete Vibrator Shafts - Flexible Type (Please indicate desired shaft when ordering.)

For VR600

Size	Part Number
Dia. ø30mm x 1020mm(M40 x P1.5)	305-00077-000-008
Dia. ø30mm x 1800mm(M40 x P1.5)	305-00077-000-009

For VRN1400

Size	Part Number
Dia. ø30mm x 1020mm(M42 x P1.5)	305-00077-000-001
Dia. ø30mm x 1800mm(M42 x P1.5)	305-00077-000-002
Dia. ø30mm x 3020mm(M42 x P1.5)	305-00077-000-003
Dia. ø39mm x 1000mm(M42 x P1.5)	305-00077-000-004
Dia. ø39mm x 1780mm(M42 x P1.5)	305-00077-000-005
Dia. ø39mm x 3000mm(M42 x P1.5)	305-00077-000-006

Model	VR600	VRN1400
Power Input	3A (220-240V), 5.5A (110-120V)	8.4A (220-240V), 14.8A (110-120V)
Power Output	330W	830W
Voltage	110-120V~ 50-60Hz, 220-240V~	50-60Hz
No Load min ⁻¹	20,000	16,000
Vibration Rate	14,000 vpm	11,000 vpm
Applicable Vibrator Shaft Types	AZ017, AZ013	AZ013, AZ014, AZ015, AZ017, AZ018, AZ019
Soft Start	Without	With
Dimensions(LxWxH)(Motor unit only)	375mm x 270mm x 160mm	290mm x 234mm x 243mm
Net Weight (Motor unit only)	2.5kg (5.51 Lbs)	4.2kg (9.26 Lbs)



STANDARD ACCESSORIES

VR600

* Side Handle x1

VRN1400

* Side Handle x1

* Support Strap x1

ROTARY BUSH HAMMER

The specialized tool for roughening smooth stone surfaces. Perfect for creating non-slip strips on stone stairs.

This Rotary Bush hammer is designed for texturing and roughening of smooth stone surfaces. This is especially important for performing operations to create anti-slip surfaces on stone floors and steps. The parallel guide allows the creation of perfectly straight lines. There are different mounting positions for the Bush hammer Roll Tool Holders to create different working widths.

The 1200 W motor is equipped with variable full wave electronic speed stabilization for an even texture. No matter the load, the motor keeps the same even speed.

Effective and convenient dust extraction system for a healthy and mess-free job.

Includes a bayonet adaptor end to allow connection to your vacuum cleaner hose.

Comfortable handles help keep vibration away from the hands.



Bayonet Adaptor End



Plastic Carry Case

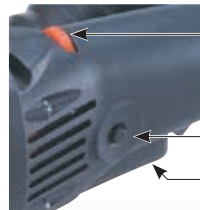

Speed control thumb wheel with Feedback speed stabilization

Lock Button

Trigger Switch

High efficiency 1200W motor with variable electronic speed stabilization



Effective dust extraction system with swiveling bayonet mount

Ergonomic downforce handle

Fully adjustable parallel guide may be mounted in the 9, 12, or 3 o'clock positions for creating straight textured strips.

Bushhammer rolls (included) can be mounted to create 51, 70, 96, or 116mm wide textured strips

■ BH92 Replacement Carbide Bushhammer Discs-(Set of 6)



Description

Bushhammer Roll Disc
(Each machine requires 6 pcs)

Part Number

302-02017-000-001

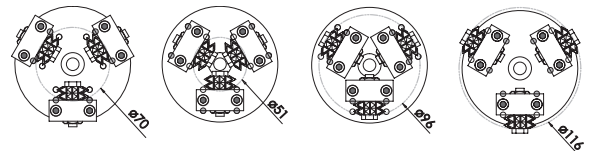

Plastic Carry Case

572mm x 362mm x 238mm

0299-0075-00100-011



Model	BH92
Power Input	1200W
Voltage	110-120V~ 50-60Hz, 220-240V~ 50-60Hz
No Load min ⁻¹	1600 - 3200
Bushhammering Diameters	51, 70, 96, or 116mm
Max. Cutting Depth	2.5mm
Soft Start	With
Dimensions (LxWxH)	470mm x 178mm x 150mm
Net Weight	4.9kg(10.8Lbs)

STANDARD ACCESSORIES

- * Bushhammer Roll Discs x6
- * Parallel Guide x1
- * Hex. Wrench M5 x1
- * Bayonet Adaptor End x1
(For Connecting To Your Vacuum Cleaner Hose)

LONG-REACH DIAMOND GRINDER

The 125mm Long-Reach†Diamond Grinder, It's really an exciting tool with excellent possibilities. It's extremely light in weight at only 3.8 kg for fatigue-free operation. Although it is light, the motor is very powerful at 1200W with electronic speed stabilization. This allows the same speed to be maintained, no matter the load. It is very easy to control and almost all of the dust and debris are controlled by the vacuum system. This saves time and trouble in cleanup. The operation is the most comfortable possible, whether grinding floors from a standing position or grinding walls or ceilings without scaffolding or ladders. Huge amounts of both time and effort are saved



	Dust Collect Cover	Part Number 203-0008-00004-007
	Outer Flange M14	302-04176-903-002
	Outer Flange 5/8"	302-04176-903-003
	Inner Flange 22.2mm	302-04222-903-001 (M14)
	Inner Flange 25.4mm	302-04222-903-002 (M14)
	Inner Flange 22.2mm	302-04222-903-004 (5/8")
	Diamond Cup Wheels #60/80 Grit (22.2mm)	305-00072-000-018
	#100/120 Grit (22.2mm)	305-00072-000-020
	Aluminum Backing Pad M14	201-0045-00906-001
	Aluminum Backing Pad 5/8"	201-0045-00906-002



Model	LG125
Power Input	1200W
Voltage	110-120V~ 50-60Hz, 220-240V~ 50-60Hz
No Load min ⁻¹	1700-3500
Length	1475 mm
Max. Capacity	125 mm
Arbor	22.23mm (7/8") or 25.4mm (1")
Spindle	M14 or 5/8 -11
Soft Start & Overload Protection	With
Dimensions(LxWxH)	1475mm x 197mm x 365mm
Net Weight	3.8 kg (8.38 Lbs) (Not including Diamond Cup Wheel)

STANDARD ACCESSORIES

- * Vacuum Hose 4M x1
- * Carry bag x1
- * Bail Handle x1
- * Face Spanner Wrench-78mm x1
- * M17 Wrench x1
- * Hex Key M6 x1
- * 125 mm Diamond Cup Wheel x1 (100/120 Grit)

CONCRETE GRINDER

PATENTED

The **SM5**, when combined with the optional wearable dust bag system, is a revolutionary self-contained concrete grinding system. The built-in turbine exhausts the dust into the special, wearable dust bag with straps and vacuum hose. This eliminates the need for a separate vacuum cleaner, giving the operator unprecedented mobility. Working dust-free and without encumbrance, this makes working over large areas easier than ever before. It's especially useful in situations where it's difficult to use a vacuum cleaner; like working in high places or grinding stairs. This is an excellent design and dust collection efficiency is truly effective. Of course, it can also be used with vacuum cleaner if desired. The handle assembly is anti-vibration rubber mounted for operator comfort. The dust skirt includes a tool-free half-moon door for edge grinding. Speed is adjustable to suit various operating conditions. The motor uses sophisticated electronic control circuitry, which includes soft start, overload and speed stabilization electronics for even speed under all load conditions. This results in an excellent finish. Use the optional floor grinding trolley for fatigue free floor grinding from a standing position. In our unique design, the operator uses side mounted handles which allows much superior control of the grinder's movement and more leverage. It pivots on 2 casters and its spring suspension allows the machine to be held perfectly parallel to the work surface. It's very convenient, with a separate master switch, hooks for holding the vacuum hose and coiling the power supply cable.



Floor Grinding Trolley



Model	SM5
Power Input	110-120V:1700W, 220-240V:2200W
Voltage	110-120V~ 50-60Hz, 220-240V~ 50-60Hz
No Load/min ⁻¹	4500 - 9500
Wheel Diameter	125mm (5")
Arbor	22.23mm (7/8") & 25.4 (1") (Double-Sided)
Spindle	M14 or 5/8-11
Soft Start & Overload Protection	With
Dimensions (LxWxH)	246mm x 280mm x 325mm
Weight	5.75kg (12.65 Lbs)

- STANDARD ACCESSORIES**
- * Lock Nut Wrench x1
 - * Face Spanner Wrench x1
 - * Hex Key M6 x1
- OPTIONAL ACCESSORIES**
- * Floor Grinding Trolley x1
 - * Various Grits of Diamond Cup Wheel x1 (See page 66)
 - * Wearable Dust Bag w/ Straps & Hose 1.0m x1

CONCRETE GRINDER

The **SM7** is a purpose-built 180mm concrete grinder with excellent dust control, ideal ergonomics and optimized power characteristics for fast grinding results.

The handle assembly is anti-vibration rubber mounted for operator comfort. The dust skirt has a spring suspension to allow it to follow irregularities in the work surface and a swiveling dust port to ensure the best possible dust collection. It also uses a tool-free half-moon door for edge grinding. Speed is adjustable to suit various operating conditions. The motor uses sophisticated electronic control circuitry, which includes soft start, overload and speed stabilization electronics for even speed under all load conditions. This results in an excellent finish. Use the optional floor grinding trolley for fatigue free floor grinding from a standing position. In our unique design, the operator uses side mounted handles which allows much superior control of the grinder's movement and more leverage. It pivots on 2 casters and its spring suspension allows the machine to be held perfectly parallel to the work surface. It's very convenient, with a separate master switch, hooks for holding the vacuum hose and coiling the power supply cable.



Model	SM7
Power Input	110-120V:1700W, 220-240V:2200W
Voltage	110-120V~ 50-60Hz, 220-240V~ 50-60Hz
No Load/min ⁻¹	3200 - 6500
Wheel Diameter	180mm (7")
Arbor	22.23mm (7/8") or 25.4 (1")
Spindle	M14 or 5/8-11
Soft Start & Overload Protection	With
Dimensions(LxWxH)	246mm x 280mm x 325mm
Weight	5.74kg (12.62 Lbs)

STANDARD ACCESSORIES

- * Lock Nut Wrench x1
- * Face Spanner Wrench x1
- * Hex Key M6 x1

OPTIONAL ACCESSORIES

- * Floor Grinding Trolley
 - * Various Grits of Diamond Cup
- Please see p.66

SCOURING MACHINE

- Versatile for removal of soft plaster surfaces; elastic protection on walls and floors; foam crests and adhesive remainders; asphalt and protective coatings for concrete; latex or oil paint on gypsum surfaces; and removal of impurities and contamination on concrete surfaces.
- Superior at grinding off irregularities and projections on plaster flooring and roughing, cleaning and smoothing out irregularities of aged concrete.
- Movable rubber base platform that bends and swivels according to the surface -putting less strain on the user's wrists.
- Ergonomically designed to decrease user fatigue.
- Side handle (able to attach to either side of the machine) improves handling of machine
- Dust free operation- attaches directly to standard vacuum hose.
- All three types of abrasive materials, carbide cutter discs, diamond cup grinding heads and TC grinding heads are easily replaced when worn out.



Front Handle

Movable rubber platform that swivels and bends according to the surface

T-Arm for SM125 Scouring machine

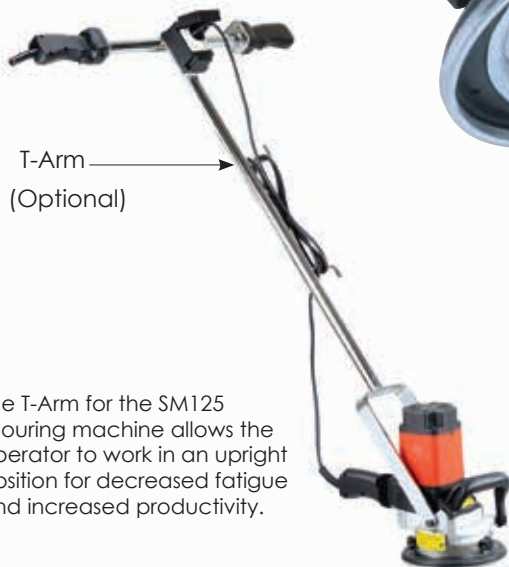

The T-Arm for the SM125 scouring machine allows the operator to work in an upright position for decreased fatigue and increased productivity.

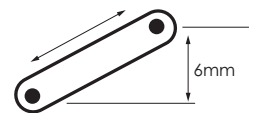

Edge Cut-Out in gear box

New cover which enshrouds the Edge Cut-Out when the Base is in place.



This will allow the accessory Diamond Grinding Head or Diamond Cup Wheel to reach right up to the edge. (It is not possible for the Scarifier Wheel to reach all the way to the edge).



Model	SM125
Power Input	1200W
Voltage	110-120V~ 50-60Hz, 220-240V~ 50-60Hz
No Load min ⁻¹	2800
Milling Head	125 mm
Milling Depth	1-6mm
Dimensions (LxWxH)	352mm x 300mm x 265mm
Net Weight	5.4 kg (11.9 Lbs)

STANDARD ACCESSORIES

- * Side Handle x1
- * T-Wrench 13mm x1
- * Scarifier Wheel with Pyramid-Tip Cutter Discs x1
- * Wheel Puller x1
- * Face Spanner Wrench-93mm x1 (for Scarifier Wheels)
- * Vacuum Hose End Adaptor x1

OPTIONAL ACCESSORIES

- * Overload Protection

■ Rotary Scarifier Wheels

Pyramid-Tip Cutter Discs (Standard)



The **SM125** comes complete with a Rotary Scarifier Wheel with a set of Pyramid-Tip Carbide Cutter Discs. Ideal for very hard materials, it aggressively removes material and leaves behind a roughened surface. The adjustable shroud allows controlled depth.

Pyramid-Tip
Cutter Discs-(Set of 15)

Part Number
0299-0108-00000-001

OPTIONAL ACCESSORIES:

■ Diamond Grinding Head Mounting Kit

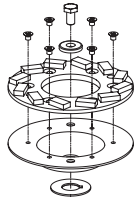

Allow the use of flat type diamond grinding heads
(Grinding heads not included)

Mounting Kit
Mounting Cup only x1
Flat Head Screw x1
(6 pcs required)

Part Number
302-03100-903-001
415-M05008080-080

■ Standard-Type Diamond Cup Wheels

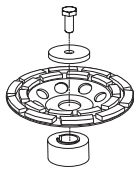

These discs are perfect for grinding concrete and similar materials. Coarse grit for aggressive removal. Fine grit for a smoother finish.

Diamond Cup Wheels x1
125mm discs with 7/8" (22.2mm) bore
#60/80 Grit
#100/120 Grit

Part Number
305-00072-000-018
305-00072-000-020

Mounting Accessories Required for Diamond Cup Wheels

(When ordering diamond cup wheel, 1pcs of each spacer, outer flange, long arbor bolt, and 78mm face spanner wrench are required.)

Arbor Bolt-Long x1
Spacer x1
Outer Flange x1

401-M08035125-080
302-04180-903-001
302-04181-903-001

■ Face Spanner Wrench



Face Spanner Wrench-78mm x1

302-04179-901-002

■ T-Arm (for SM125 only)



T-Arm (for SM125 only) x1
Dimensions : 1120mm (L) x 780mm (W) x 115mm (H)
Weight: 3kg (6.6 Lbs)

■ Plastic Carry Case x1



Application	Outer Dimensions	Part Number
SM125	572mm x 362mm x 238mm	0299-0075-00100-001

HAND-HELD DRYWALL SANDER

The unique machine is designed especially for low-effort sanding of drywall.

This machine makes the tedious task of sanding drywall much faster and easier. In easy-to-reach areas, it is much lighter and more convenient. It uses a high efficiency dust collection system and sanding mesh discs for dust-free and clog-free sanding. It works perfectly with our purpose-built DE25 vacuum cleaner. The ergonomic bail handle and light weight allow sanding in maximum comfort. The routing of the vacuum hose and cable keep them out of your way. The electronic speed stabilization maintains the speed regardless of the load for a perfect sanding finish. It is the perfect complement to our long-reach sander. The long-reach model can be used for all the hard-to-reach areas, and this machine can easily do the rest.

- The 1200 W motor is equipped with variable electronic speed stabilization for smooth, consistent results. No matter the load, the motor keeps the same even speed.
- Effective and convenient dust extraction system for a healthy and mess-free job.
- Includes a bayonet adaptor end to allow connection to your vacuum cleaner hose.



Dust Hood with half-moon door to even sand into corners



Plastic Carry Case 572mm x 362mm x 238mm
Part Number 0299-0075-00100-004



Bayonet Adaptor End



Model	HS225
Power Input	1200W
Voltage	110-120V~ 50-60Hz, 220-240V~ 50-60Hz
No Load min ⁻¹	650 - 1450
Sanding Disc Diameter	225mm
Soft Start	With
Dimensions(LxWxH)	515mm x 258mm x 214mm
Net Weight	3.0 kg (6.61 Lbs)

STANDARD ACCESSORIES
* Bayonet Adaptor End (for connecting to your vacuum hose) x1

ELECTRIC DRYWALL SANDER

The most efficient possible method of sanding drywall and plaster walls and ceilings. Get the job done many times faster, with less effort and with better results than ever before. All in the comfort of a more dust free work environment.

- With its 4 meter hose with bayonet swivel connection, it's designed to work with a vacuum so there is less dust in the air, less sandpaper clogging and no after-cleanup needed.
- The pivoting sanding head follows the contours of the work to allow a perfect, swirl-free finish.
- The speed is infinitely variable between 650 and 1800 rpm so you can tailor the speed to the work surface for best results.
- The hook and loop backed sandpaper discs and backing pads take only seconds to change.
- Less scaffolding is needed since it can sand most ceilings just standing on the floor.
- The excellent balance and light weight allow you to finish the job without fatigue.



Model	GS9FSE	GS9FE
Power Input	550W	550W
Voltage	110-120V~ 50-60Hz, 220-240V~ 50-60Hz	
No Load min ⁻¹	650 - 1800	650 - 1800
Full Load min ⁻¹	380 - 950	380 - 950
Grinding Disc	ø225 mm (8-7/8 in.)	ø225 mm (8-7/8 in.)
Soft Start	With	With
Dimensions(LxWxH)	1058mm x 260mm x 310mm	1580mm x 260mm x 350mm
Net Weight	3.8 kg (8.38 Lbs)	4.7 kg (10.36 lbs.)

STANDARD ACCESSORIES

- * Vacuum Hose 4M x1
- * Bail Handle x1
- * Carry Bag x1
- * Velcro Strap x1

OPTIONAL ACCESSORIES

- * Hose Protector x1
- * Overload Protection

OPTIONAL ACCESSORIES:

■ **225mm Fabric Mesh Dustless Sanding Discs x1**

Designed specifically for use with our Drywall Sanders for truly dust-free sanding. Anti-clog and very long-lasting. (25 pcs / pack)



9"

Grit	Part Number
#60	305-00183-000-002
#80	305-00183-000-003
#100	305-00183-000-004
#120	305-00183-000-005
#150	305-00183-000-006
#180	305-00183-000-007
#220	305-00183-000-008
#400	305-00183-000-009



Hook & Loop Sponge Pad x1

Description

Black-White W/ 6 Holes
White-White W/ 6 Holes

Part Number

303-02008-004-001
303-02008-004-002



Vacuum Hose 4M
W/ Bayonet Adaptor x1

Part Number

0203-0007-00004-001



Bail Handle for GS9FE x1

Part Number

0203-0050-00004-001



Velcro Straps
for securing the cable
to the hose x1

Part Number

305-00150-000-002



Hose Protectorx1

Part Number

0299-0091-00000-001



Carry Bag for GS9FE x1
Carry Bag for GS9FSE x1

Part Number

308-01001-149-003
308-01001-149-008

ROTARY POLISHER

The **SP2500** is a perfect workhorse rotary polisher suited to a wide range of tasks from compounding to polishing to buffing. It can also be used as a high torque-low speed sander. The non-orbital rotary motion works quickly and is especially suited to quickly repairing damage and surface imperfections such as scratches, oxidation, and paint swirls.

The direct-drive vertical design is very compact and easy to handle. It can drive a 180mm pad.

The powerful 900 watt motor incorporates soft start and electronic speed control for excellent speed stability and maximum torque. The step less electronic variable speed thumb wheel gives the operator excellent control of the speed, which translates into consistent polishing results.



Model	SP2500
Power Input	900W
Voltage	110-120V~ 50-60Hz, 220-240V~ 50-60Hz
No Load min ⁻¹	900-2500
Spindle	M16 (other sizes upon request)
Max. Recommended Pad Diameter	180mm (7")
Dimensions(LxWxH)	240mm x 212mm x 230mm(Not Included Polishing Pad)
Net Weight	2.2kg(4.85Lbs)

STANDARD ACCESSORIES

- * Side Handle x1
- * M17 Wrench x1

OPTIONAL ACCESSORIES

- *180mm Polishing Pad x1

ROTARY SANDER

The **SP4000** is a perfect workhorse rotary sander suited to efficient sanding of wood, paint, varnish, plastics, fiberglass and others. The high torque makes it perfect for aggressive coatings stripping as well as material shaping. It's also excellent for rust removal and metal polishing. The non-orbital rotary motion has very high removal rates for covering large areas quickly.

The direct-drive vertical design is very compact and easy to handle. It can drive a 150mm pad.

The powerful 900 watt motor incorporates soft start and electronic speed control for excellent speed stability and maximum torque. The step less electronic variable speed thumb wheel gives the operator excellent control of the speed, which translates into consistent sanding results.



Model	SP4000
Power Input	900W
Voltage	110-120V~ 50-60Hz, 220-240V~ 50-60Hz
No Load min ⁻¹	2000-4200
Spindle	M16 (other sizes upon request)
Max. Recommended Pad Diameter	150mm (6")
Dimensions(LxWxH)	240mm x 212mm x 230mm(Not Included Sanding Pad)
Net Weight	2.1kg(4.63Lbs)

STANDARD ACCESSORIES

- * Side Handle x1
- * M17 Open End Wrench x1

OPTIONAL ACCESSORIES

- *150mm Sanding Pad x1

ROTARY POLISHER

The **RP220** and **RP160** rotary polishers are ideally suited to all polishing tasks, from compounding to polishing to finish polishing and buffing. Rotary polishers (also known as a circular polishers) are designed for working quickly, especially on harder paint types. They are especially suited to quickly repairing damage and surface imperfections such as scratches, oxidation, and paint swirls.

The pad spins on one axis, so much work can be done quickly. The key feature of a rotary polisher is perfectly stable rotation speed with precise operator control over the speed. Speed is adjusted two ways, giving the operator excellent control. The thumb wheel sets the maximum speed, while the trigger increases the speed steplessly from zero upwards to the maximum. The trigger is the best available: it's large and easy to smoothly control.

This machine incorporates speed stabilization so that the speed will not slow with load. It will maintain the preset speed regardless of the load. This results in a perfect finish. A constant speed will help in avoiding holograms and also help reduce buffer hop and other unwanted polisher effects.

High efficiency motor with variable electronic speed stabilization for perfectly even speed under all loads. This results in the smoothest possible finish.



STANDARD ACCESSORIES

RP160:
* Side Handle x1

RP220:
* Side Handle x1

OPTIONAL ACCESSORIES:

* Front Handle (RP160 only) x1
* Bail Handle (RP220 only) x1

Model	RP160	RP220
Power Input	1200W	1700W
Voltage	110-120V~ 50-60Hz, 220-240V~ 50-60Hz	
No Load min ⁻¹	1000 ~ 2400	800 ~ 2400
Spindle	M14 or M16 (Specify when ordering)	
Max. Recommended Pad Diameter	150mm	180mm
Soft Start & Overload Protection	With	With
Dimensions (LxWxH) (Not Included Loop Sponge Pad)	378mm x 213mm x 127mm	430mm x 221mm x 140mm
Net Weight	2.3 kg (5.07Lbs)	3.4 kg (7.5Lbs)

ELECTRIC MIXER

- The heart of our mixer line is a combination of revolutionary ergonomic design, sturdy mechanicals and speed control electronics. These combine to make our mixers the most effective and comfortable mixers available anywhere.
- The unique handle design results in the perfect hand position with 15 degree tilt for fatigue-free operation. The rubber grip areas help provide maximum comfort. Ergonomics at its best!
- The speed control function (on 120mm models and above) allows maximum torque to be maintained at any speed. Changing the speed without leaving the handles is easy with the speed adjustor thumb wheel. This allows the machine to mix at maximum efficiency with any kind of media.



ELECTRIC MIXER



EV32

EV42

EV52

EV160



STANDARD ACCESSORIES

- * Wrench 22mm x1
- * Mixing Paddle with 2 Helix x1

OPTIONAL ACCESSORIES

- * Mixing Paddles (See P.94)

Model	EV32	EV42
Power Input	800W	1100W
Voltage	110-120V~ 50-60Hz, 220-240V~ 50-60Hz	
No Load min ⁻¹	750	250-700
N-m (Low Gear / High Gear)	6.0	11.0
Number Of Gears	2	1
Amps (110V)	7.20	10.00
Amps (230V)	3.60	4.80
Thread For Fixing The Tool	M14 x P2.0	M14 x P2.0
Mixing Paddle (Max.)	105mm (4-1/8 in.)	120mm (4-11/16 in.)
Electronic Speed Control	N/A	With
Dimensions(LxWxH)(Motor unit only)	322mm x 250mm x 190mm	322mm x 312mm x 190mm
Net Weight	2.9 kg (6.39Lbs)	3.6 kg (7.94Lbs)

Model	EV52	EV160
Power Input	1300W	1600W
Voltage	110-120V~ 50-60Hz, 220-240V~ 50-60Hz	
No Load min ⁻¹	150-400 / 250-700	180-350 / 280-550
N-m (Low Gear / High Gear)	27.4 / 17.3	42.7 / 29.9
Number Of Gears	2	2
Amps (110V)	10.90	14.50
Amps (230V)	5.20	7.00
Thread For Fixing The Tool	M14 x P2.0	M14 x P2.0
Mixing Paddle (Max.)	140mm (5-1/2 in.)	160mm (6-5/16 in.)
Electronic Speed Control	With	With
Dimensions(LxWxH)(Motor unit only)	345mm x 322mm x 190mm	350mm x 322mm x 190mm
Net Weight	4.1kg (9.04Lbs)	5.6kg (12.35 Lbs)

ELECTRIC MIXER



ELECTRIC MIXER / DRILL



OPTIONAL ACCESSORIES :



Use hex shank paddle with the chuck or M14 shank paddle with the M14 adaptor



Model	EV10ELM	EVP180	EV21
Power Input	1100W		
Voltage	110-120V~ 50-60Hz, 220-240V~ 50-60Hz		
No Load min ⁻¹	0~750	750	800
N-m	12.6	12.6	12.6
Gear	1 Speed		
Spindle Thread	M14xP2.0	1/2"-20 Unf	
Max. Mixing Paddle Diameter	120mm (4-11/16")		
Drilling Capacity	Steel:	—	
	Wood:	—	
Switch	Variable Speed	Single Speed	
Handle	Tubular Steel	—	
Dimensions(LxWxH)(Motor unit only)	475mm x 380mm x 225mm	390mm x 100mm x 130mm	300mm x 95mm x 410mm
Net Weight	4.8kg(10.58Lbs)	3.1kg (6.83 Lbs)	2.9kg (6.39 Lbs)

STANDARD ACCESSORIES

- * Wrench M22 (EV10ELM Only) x1
- * Wrench M13 (EV10ELM only) x1
- * M6 L-Hex Key(EV10ELM only) x1
- * M14 Adaptor (EVP180, EV21 only) x1

OPTIONAL ACCESSORIES

- * Mixing Paddles (See P.94)
- * Variable Speed Switch (EV10ELM only)
- * Soft Start (EV21 only)
- * 13mm Chuck & Chuck Key (EVP180, EV21 only)



BUCKET MIXER

A powerful and reliable mixing solution for a wide variety of media, the **AM5000** is the most labor saving mixer available. It is much safer than a hand-held mixer. Simply load it, then let the machine do the work! Even the most viscous materials get mixed thoroughly and fast by the high torque motor. When done, just swing the motor head out of the way and lift away the bucket. The **AM5000** is easily portable with its built-in folding T-handle and wheels. Just wheel it around the jobsite like wheeled luggage.



Safety Interlock Switch automatically shuts down the machine when opened.

OPTIONAL ACCESSORIES:



Non-reinforced 50L Bucket



Reinforced 50L Bucket



Bucket Cart



AM5000NC
(Steel Grating Cover Version)

	Part Number
Non-reinforced 50L Bucket	0299-0024-00000-001
Reinforced 50L Bucket	0299-0024-00000-002
Bucket Cart CART12	0299-0046-00000-001









Model	AM5000	AM5000NC	CART12
Power Input	750W		
Voltage	110-120V~ 50-60Hz, 220-240V~ 50-60Hz		
No Load min ⁻¹	65		
Max. Torque	105 N-m		
Motor	AC Induction Motor, Class F		
Max. Capacity	50 L		
Protection	IP 44		
Dimensions(LxWxH)	940mm x 580mm x 780mm		
Net Weight (including bucket)	31.2kg (68.78 Lbs)	34.6kg (76.28 Lbs)	8.7kg (19.18 Lbs)

STANDARD ACCESSORIES

- * Non-reinforced 50L Bucket x1
- * Agitator x1
- * M2.5 L-Hex Key x1 (AM5000NC Only)



■ Mixing Paddles Optional Accessory Specifications

	Hex.	M14				
	Description		Part Number	Diameter	Length	Mount
	TT Series 2 Helix (General Purpose), Suitable for a wide range of uses.		302-04155-905-001	120mm	575mm	M14
			302-04155-905-011	140mm	590mm	M14
			302-04155-905-004	160mm	590mm	M14
	Description		Part Number	Diameter	Length	Mount
	TV Series 2 Helix (General Purpose), Like the TT series.		302-04155-905-003	90mm	400mm	Hex.
			302-04155-905-015	120mm	590mm	Hex.
	Description		Part Number	Diameter	Length	Mount
	TU Series 3 Helix (High Viscosity) Positive Twist (Pulls from the bottom up) For the highest viscosity materials		302-04155-905-007	120mm	590mm	M14
			302-04155-905-012	140mm	590mm	M14
			302-04155-905-008	160mm	590mm	M14
	Description		Part Number	Diameter	Length	Mount
	TS Series 3 Helix (High Viscosity, Negative Twist) (Pushes from the top down). Anti-splash effect.		302-04155-905-018	120mm	590mm	M14
			302-04155-905-019	140mm	590mm	M14
			302-04155-905-009	160mm	590mm	M14
	Description		Part Number	Diameter	Length	Mount
	Double Mixer-Left Hand Double Mixer-Right Hand		302-04155-905-006	125mm	650mm	Hex. Quick Release
			302-04155-905-005	125mm	650mm	Hex. Quick Release
	Description		Part Number	Diameter	Length	Mount
Round Bar 2 Helix (Low Load- High Speed)		302-04155-905-002	105mm	575mm	M14	
	Description		Part Number	Diameter	Length	Mount
	Gate Type- (Low-Speed) Hex Gate Type- (Low-Speed) M14		302-04155-905-013	6"	29"	Hex.
			302-04155-905-014	6"	29"	M14
	Description		Part Number	Diameter	Length	Mount
Anti-stick paddle. Excellent for avoiding lumps when mixing fine powders.		302-04155-905-016	120mm	630mm	M14	
	Description		Part Number	Diameter	Length	Mount
Stainless steel, suitable for food processing.		302-04155-905-017	125 mm	650mm	M14	

VACUUM PUMP

This purpose-built vacuum pump is specifically designed for use with power tools which are anchored by a vacuum base, such as vacuum base diamond core drilling rigs and others.

Traditionally there is always a safety concern due to the possible loss of vacuum during power tool operation. This machine has two powerful safety mechanisms which address this. The first is the warning buzzer which signals whenever the vacuum is less than 0.77 bar. The second is the vacuum-dependant power supply socket. The power tool is plugged into this power supply socket on the vacuum pump. This socket is only energized when the vacuum has achieved the pre-set minimum of 0.77 bar. If for any reason the vacuum is leaking, the power tool will have its power shut off and the warning buzzer will alert the operator.

This pump is also ergonomically designed with perfect weight balance for easy carrying.



Vacuum Tank(Optional)



Model	VP140
Power Input	200W
Voltage	110-120V~ 50-60Hz, 220-240V~ 50-60Hz
Air Flow	30.5 l/min (1.07cfm)
Max. Vacuum	-0.9 bar (-13 psi)
Protection	IPX4
Dimensions(LxWxH)	310mm x 238mm x 250mm
Net Weight	6.7kg (14.77 Lbs)

STANDARD ACCESSORIES

* Air Hose 2.5M x1

OPTIONAL ACCESSORIES

* Vacuum Tank (Includes Air Hose 1M) x1

TILE CORE DRILL

The tile core drills are specially designed to use small diamond core bits for wet or dry drilling either blind or through holes in tiles, ceramics, porcelain, stone, concrete, masonry, glass and similar materials.

Anyone who has tried to drill tiles with a rotary hammer knows just how easy it is to crack them or drill off center. These machines can drill tiles with precise control and without any chance of cracking. Even hard materials like porcelain and granite can be drilled with ease.

The quick-release bits are easy to remove for clearing the cores. The optional autonomous pressurized water tank with adjustable flow is very convenient and allows for operating on job sites without a water supply. (It can also be connected to an outside water supply with the optional water supply kit if desired). The suction centering guide doubles as a slurry collector and allows precise control while minimizing mess.

The perfect solution for drilling small holes in tiles.

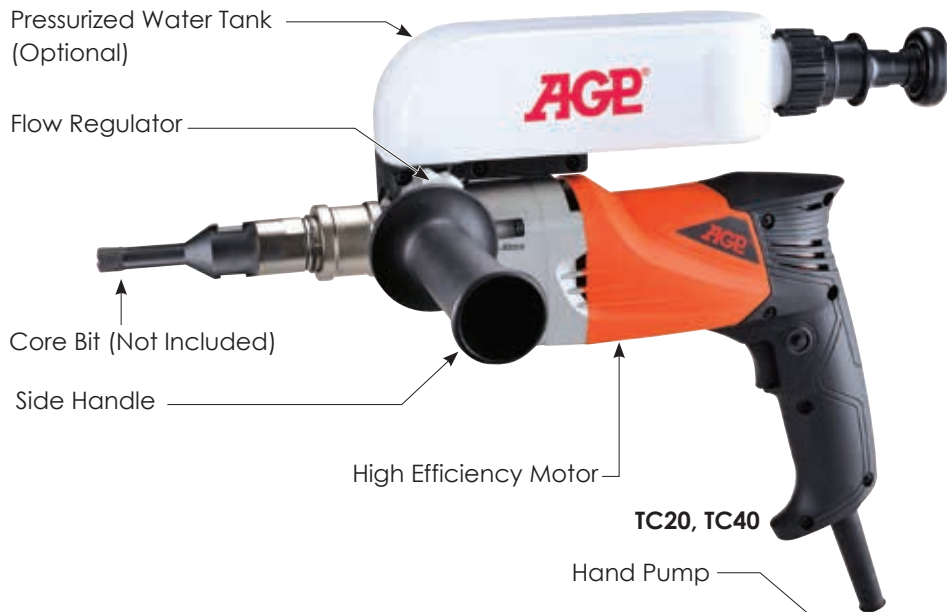

Water Supply Kit

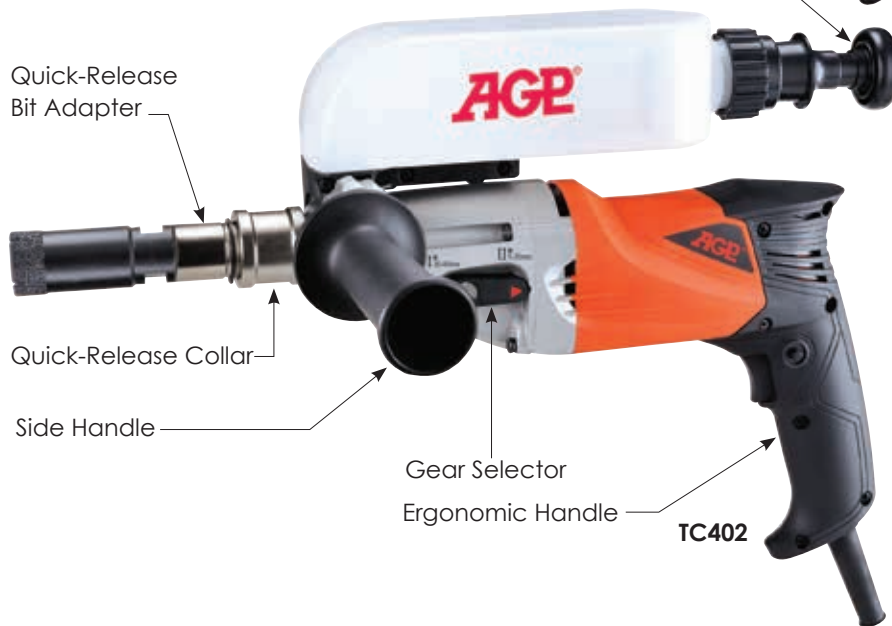
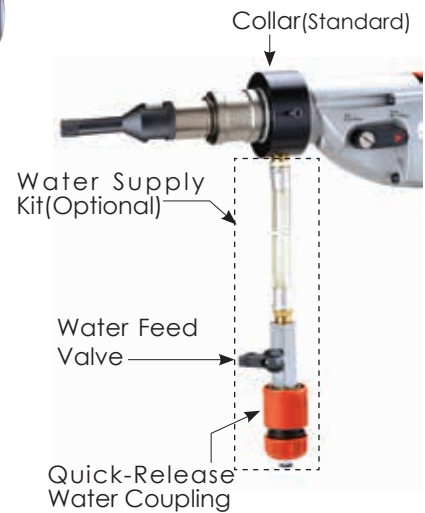

Suction Centering Guide (Standard)



Model	TC20	TC40	TC402	
Power Input	650W			
Voltage	110-120V~ 50/60Hz, 220-240V~ 50/60Hz			
No Load / full Load min ⁻¹	Speed 1	7500 / 4500	4500 / 2700	4500 / 2700
	Speed 2	N/A	N/A	7500 / 4500
Capacity	20mm (13/16")	40mm (1-9/16")	40mm (1-9/16")	
Adapter Thread	G 1/2" (BSPP), M14-2.0			
Protection Class	Class II with PRCD / GFCI			
Neck Diameter	43mm			
Dimensions(LxWxH)	317mm x 100mm x 300mm		348mm x 100mm x 300mm	
Net Weight	2.3kg (5.07 Lbs.)		2.5kg (5.51 Lbs)	

STANDARD ACCESSORIES

- *PRCD / GFCI Interrupter x1
- *Suction Centering Guide
- *Quick-Release Bit Adapter (G 1/2") x1
- *Quick-Release Bit Adapter (M14) x1
- *M22 Wrench x1
- *M27 Wrench x1
- *Side handle x1
- *Collar x1

OPTIONAL ACCESSORIES

- *Pressurized Water Tank Kit(0.85 Liter) x1
- *Water Supply Kit x1

TILE CORE DRILL MACHINE

Our **TC100** is an all-new solution for on-site drilling of tiles which have already been laid. Ideally designed to be used in conjunction with our VP140 Vacuum Pump, The machine mounts directly to the floor for super fast and accurate drilling up to 100mm holes in even the hardest tiles like porcelain and granite. The vacuum base and stand offer excellent guidance for safe and perfectly aligned drilling. Purpose-built for wet drilling with sintered core bits, the TC100 is equipped with integrated water feed and PRCD / GFCI interrupter. A two speed gear box and adjustable height slide allow a wide range of diamond core bits to be used. A water collector ring with vacuum port is included to minimize mess. It also includes a built-in, spring-loaded centering pointer. Drilling tiles has never been easier.



Model	TC100
Power Input	1100W
Voltage	100-120V~ 50-60Hz, 220-240V~ 50-60Hz
No Load Min ⁻¹	1000 / 2000
Capacity	100mm (4")
Max. Core Bit Length	145mm
Effective Stroke	110mm
Spindle Thread	1/2"BSP
Protection Class	Class I with PRCD / GFCI
Net Weight	10.6kg(23.37Lbs)

- STANDARD ACCESSORIES**
- * T-Handle Hex Key M6 x1
 - * L-Hex Key M2.5 x1
 - * M8 Combination Wrench x1
 - * M32 Open-End Wrench x1
 - * PRCD / GFCI Interrupter x1
 - * Vacuum Base Seal x5
 - * Water Collector Ring x1

WET + DRY DIAMOND CORE DRILL

- Can drill at any angle from 0 to 45 degrees.
- Can be anchored for use with up to 120mm bits.
- High output motor for faster drilling.
- Top quality sealed ball bearing construction for long tool life.

- Massive 2200W motor.
- Cool running under industrial use.
- Heavy duty steel pole for accurate drilling.
- Circuit breaker switch for safety.



STANDARD ACCESSORIES(LY150)

- * Square Washer 3/8" x1
- * Wrench 14x17mm x1
- * Screw 3/8"x75mm x1
- * Wrench 27mm x1
- * Hex Nut 3/8" x1
- * Wrench 32mm x1
- * Driving Holder 3/8" x1
- * Anchor 3/8" x1

STANDARD ACCESSORIES(LY150)

- * Wrench 17 x 19mm x1
- * Bolt 1/2"x140mm x1
- * Wrench 36mm x1
- * Square Washer x2
- * Wrench 45mm x1
- * Water Collector x1
- * Driving Holder 1/2" x1
- * Hex. Nut 1/2" x3
- * Anchor 1/2" x2



Water Collector for LY120



Water Collector for LY150

■ Water Collector

Application
LY120
LY150

Part Number
0299-0037-00000-001
0299-0037-00000-002



* PRCD / GFCI Interrupter Protection

Model	LY120	LY150
Power input	1100W	2200W
Voltage	230V / 50Hz , 110V / 60Hz	230V / 50Hz , 110V / 60Hz
No Load r.p.m	1000	800
Capacity mm(inch)	Bit diameter: 27(1") ~ 120(4-11/16") Effective Stroke :350mm(13-13/16")	Bit diameter: 27(1") ~ 150(6") Effective stroke: 480mm (18-7/8")
Angle	0°-45°	N/A
Spindle Thread	1-1/4"-7 UNC	1-1/4"-7 UNC
Dimensions(LxWxH)	300mm x 130mm x 565mm	370mm x 200mm x 865mm
Net Weight	7.8 Kgs (17.21Lbs)	18 Kgs (39.68 Lbs)

WET + DRY DIAMOND CORE DRILL

The **DM160** is built as a heavy duty wet or dry diamond core drill. It is made to be easily converted from wet to dry use by removing the water seal mounted at the front of the gear box. The 3 speed gear box provides the ideal cutting speed and maximum torque. The slip clutch and electronic overload protection provide safe, hassle free drilling.

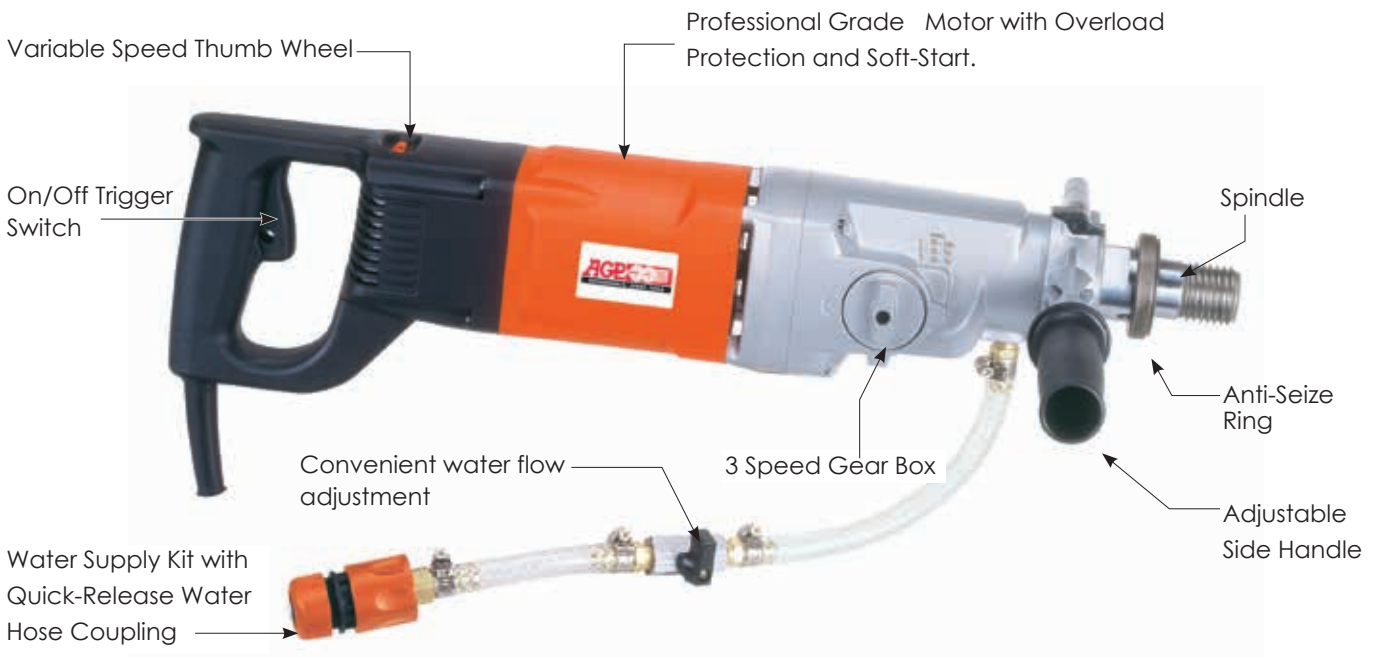

■ Quick Change Conversion to Wet or Dry.

■ Dry Core Drill Mode



■ Wet Core Drill Mode

Mounted To The Optional Rig (See P107)



■ Water Collector for DM160 (Optional)



Part Number
0299-0037-00000-002



STANDARD ACCESSORIES

- * Water Supply Kit x1
- * Side Handle x1
- * M 32 Combination Wrench x1
- * PRCD / GFCI Interrupter x1

OPTIONAL ACCESSORIES

- * Dry Arbor Adaptor x1
- * Anti-Vibration Side Handle x1
- * SDS Pilot Drill Socket x1

Model	DM160	
Power Input	110-120V:1700W, 220-240V:2000W	
Voltage	110-120V~ 50-60Hz, 220-240V~ 50-60Hz	
No load min ⁻¹	Speed 1	400-850
	Speed 2	750-1640
	Speed 3	1550-3450
Capacity	Hand-Held	80mm(3")
	Rig-Mounted	200mm (8")
Spindle Thread	Male: 1-1/4" - 7 UNC and Female: 1/2" BSP	
Neck Diameter	60mm	
Soft Start & Overload Protection	With	
Protection Class	Class I with PRCD / GFCI	
Dimensions(LxWxH)	552mm x 110mm x 150mm	
Net Weight	6.0 kg (13.2 Lbs)	

WET + DRY DIAMOND CORE DRILL

The **DM51D** and **DM51P** are very useful and effective single-speed hand-held diamond core drills. All models are equipped with our all new high efficiency 1.8kw motors which include soft start and an effective overload protection system. This system allows the operator to work at peak efficiency. As an added level of safety the single speed gear box has a mechanical slip clutch.

There are a number of key options which make this new series capable of different tasks based upon its configuration:

- For dry drilling, the switchable soft percussion function keeps the diamonds sharp and makes dry drilling much more efficient. Note: this function should not be used with wet diamond core bits. These machines may be ordered without this function if it is not needed.
- For wet drilling there is a water feed set. These machines may be ordered without this option if it is not needed.
- There are a number of spindle threads available. Please specify the spindle thread when ordering.

■ Pistol-Handle Model (DM51P)



■ D-Handle Model (DM51D)



Model	DM51P	DM51D
Power Input	110-120V:1800W (15.6A), 220-240V:1800W (7.8A)	
Voltage	110-120V~ 50-60Hz, 220-240V~ 50-60Hz	
No Load /Full Load min-1	3600 / 2160	
Percussion Frequency (optional)	56,000 bpm	
Spindle Thread	1/2" BSP female (w/ water feed) or M18 x 2.5 (dry) (Specify when ordering)	
Capacity	80mm	
Soft Start & Overload Protection	With	
Mechanical Safety Clutch	With	
Protection Class	Class II with PRCD / GFCI	
Dimensions(LxWxH)	390mm x 90mm x 280mm	450mm x 90mm x 210mm
Neck Diameter	60mm	60mm
Net Weight	4.5kg (9.92Lbs)	4.7kg (10.36Lbs)

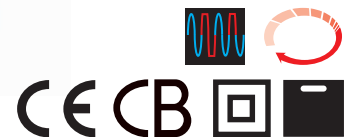

STANDARD ACCESSORIES

- * Side Handle x1
- * Water Feed Assembly x1
- * Percussion Selector (Only for Dry Drilling) x1
- * PRCD / GFCI Interrupter x1

OPTIONAL ACCESSORIES

- * Anti-Vibration Side Handle x1
- * SDS Pilot Drill Socket x1

WET + DRY DIAMOND CORE DRILL

The **DM52D, DM52P** are very useful and effective two-speed hand-held diamond core drills. They are convertible between wet drilling and dry drilling with dust aspiration. All models are equipped with our all new high efficiency 1.8kw motors which include soft start, thermal protection and our very effective overload protection system. This system allows the operator to work at peak efficiency. As an added level of safety the two speed gear box has a mechanical slip clutch. There are a number of key options which make this new series capable of different tasks based upon its configuration:

- For dry drilling, the switchable soft percussion function keeps the diamonds sharp and makes dry drilling much more efficient. **Note:** this function should not be used with wet diamond core bits. These machines may be ordered without this function if it is not needed.
- The convertible arbor port allows quick conversion between water feed and through-the-spindle dust aspiration. The water feed adaptor head and vacuum adaptor head simply fit in the port with a bayonet connection. These machines may be ordered without either of the adaptor heads if it is not needed.
- There are a number of spindle threads available. Please specify the spindle thread when ordering.

■ Pistol-Handle Model (DM52P)

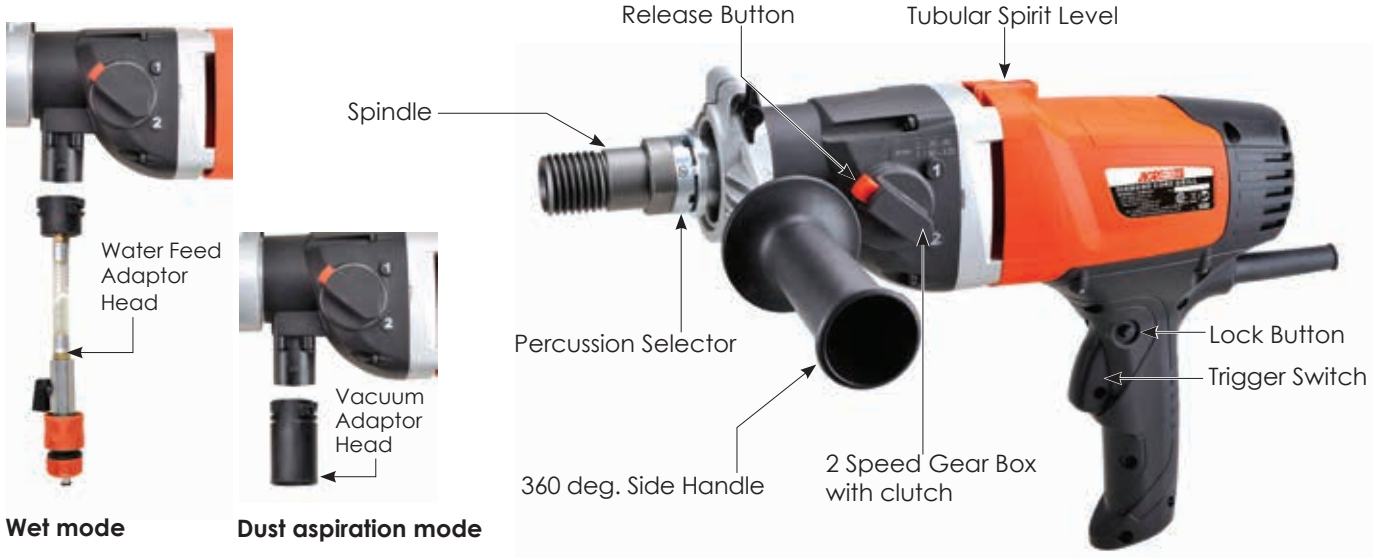

■ D-Handle Model (DM52D)



Model		DM52P	DM52D
Power Input		110-120V:1800W (15.6A), 220-240V:1800W (7.8A)	
Voltage		110-120V~ 50-60Hz, 220-240V~ 50-60Hz	
No Load /Full Load min ⁻¹	Speed 1	1800 / 1080	
	Speed 2	3600 / 2160	
Percussion Frequency (optional)	Speed 1	29,000 bpm	
	Speed 2	56,000 bpm	
Spindle Thread	1-1/4 UNC male x 1/2" BSP female (w/water feed) or M18-2.5 or 1/2" BSP (Specify when ordering)		
Capacity	120mm		
Soft Start & Overload Protection	With		
Mechanical Safety Clutch	With		
Protection Class	Class II with PRCD / GFCI		
Dimensions(LxWxH)	450mm x 105mm x 280mm		505mm x 105mm x 210mm
Neck Diameter	60mm		60mm
Net Weight	4.9kg (10.8 Lbs),		5.0kg (11.0 Lbs)

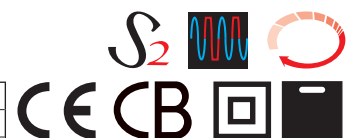

STANDARD ACCESSORIES

- * Side Handle x1
- * Water Feed Adaptor Head x1
- * Vacuum Adaptor Head x1
- * Percussion Selector (Only for Dry Drilling Mode) x1
- * PRCD / GFCI Interrupter x1

OPTIONAL ACCESSORIES

- * Anti-Vibration Side Handle x1
- * SDS Pilot Drill Socket x1

WET + DRY DIAMOND CORE DRILL

Our new **DMC6P and DMC6D** wet/dry convertible drills allow the operator the choice of wet drilling with water feed or dry drilling with through-the-spindle dust extraction. The specially made gear box port allows quick, tool-free conversion. These machines bring a whole new level of seriousness to the jobsite. No detail was overlooked when we designed these to be the most dependable, heavy-duty and efficient machines possible. The all-new super-performance motors are more efficient than ever before. The motor housing, gear box and gear plate are all made from magnesium alloy for minimal weight and maximum strength. The all-metal construction allows for both improved cooling and increased durability. The smart electronic motor control includes soft start, current and thermal overload as well as a very useful load warning system and indicator light. The tough construction also extends to the three speed oil bath gear box, with mechanical clutch and integrated water feed system. The 60mm mounting neck can also mount into a rig for even larger drilling jobs. The two-in-one spindle offers both 1-1/4" UNC and 1/2" BSP and has a built-in anti-seize ring. For electrical safety we include the PRCD / GFCI interrupter. If you're a professional and you need the best of the best, then look no further.

■ Pistol-Handle Model (DMC6P)

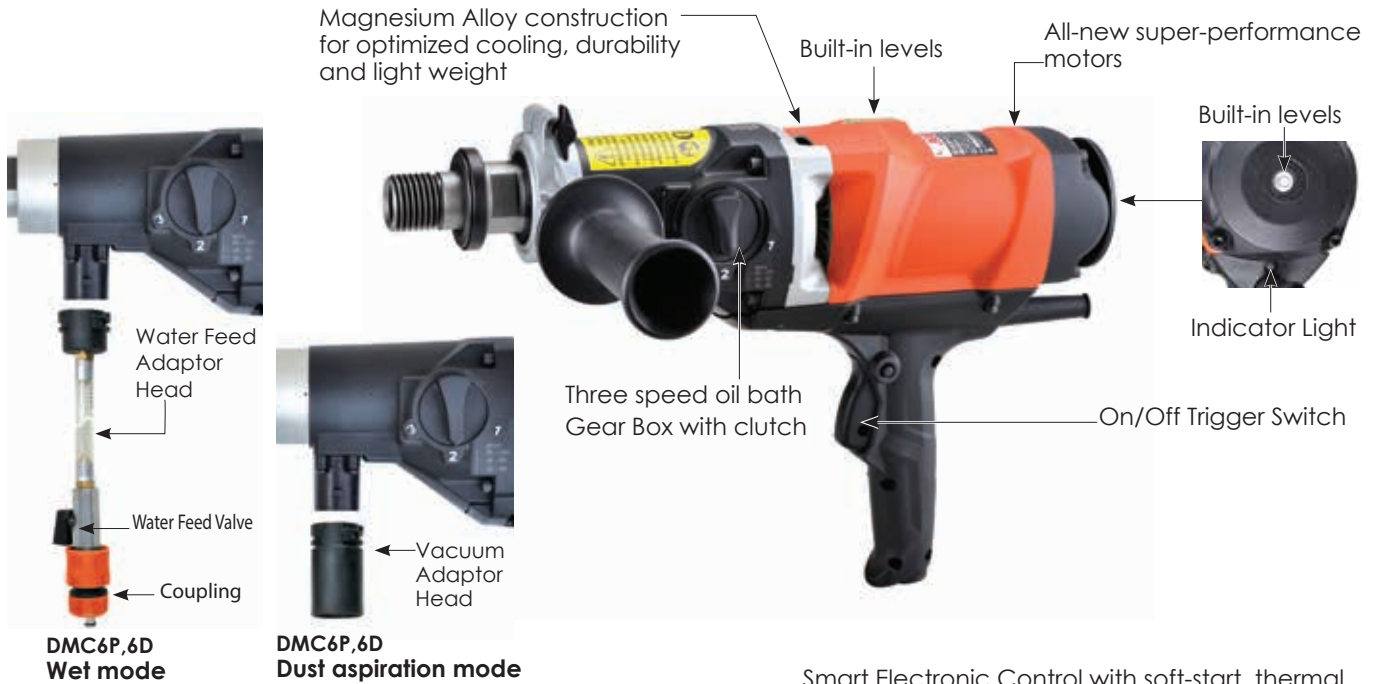

■ D-Handle Model (DMC6D)

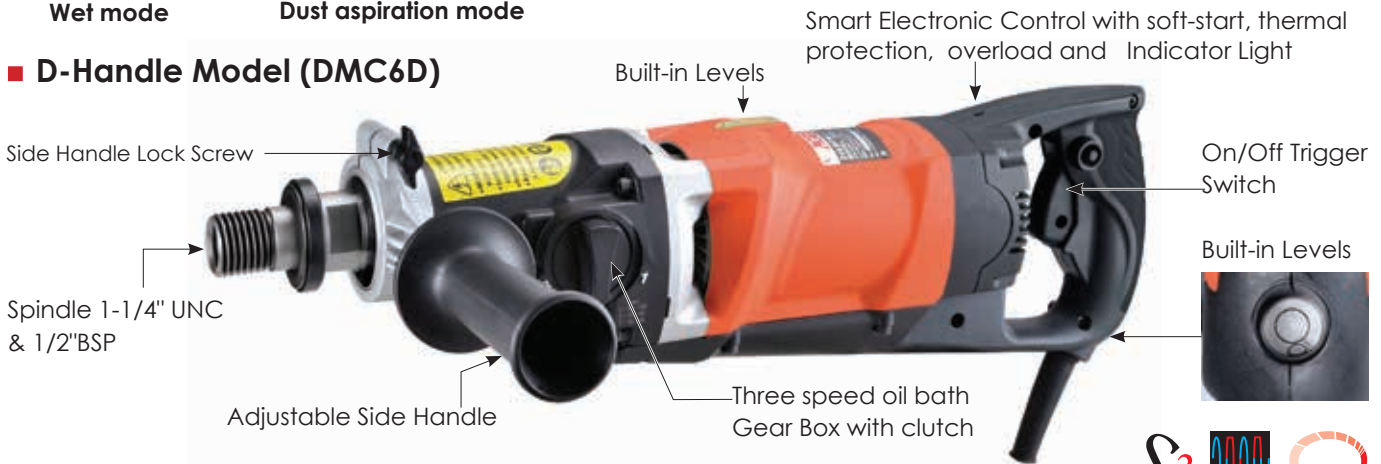

Model	DMC6P	DMC6D
Power Input	110-120V:1700W (15A), 220-240V:2000W (8.7A)	
Voltage	110-120V~ 50-60Hz, 220-240V~ 50-60Hz	
No Load min ⁻¹	930 / 1520 / 4270	
Rated Load Speeds min ⁻¹	560 / 910 / 2560	
Capacity	Hand-Held: 80mm (3")	
	Rig-Mounted: 160mm (6-1/4")	
Spindle Thread External / Internal	1-1/4" UNC & 1/2" BSP	
Neck Diameter	60mm	
Soft Start & Overload Protection	With	
Mechanical Safety Clutch	With	
Protection Class	Class I with PRCD / GFCI	
Dimensions(LxWxH)	437mm x 115mm x 289mm	528mm x 106mm x 145mm
Net Weight	6.4kg (14.08 Lbs.)	



STANDARD ACCESSORIES

- * Side Handle x1
- * Water Supply Kit x1
- * M32 Combination Wrench x2
- * Water Feed Adaptor Head x1
- * Vacuum Adaptor Head x1
- * PRCD / GFCI Interrupter x1

OPTIONAL ACCESSORIES

- * Anti-Vibration Side Handle x1
- * SDS Pilot Drill Socket x1

DIAMOND CORE DRILLING MACHINE

Our all-new **DM6P** and **DM6D** are the first in our new premium line of diamond core drilling machines and bring a whole new level of seriousness to the jobsite. No detail was overlooked when we designed these to be the most dependable, heavy-duty and efficient machines possible. The all-new super-performance motors are more efficient than ever before. The motor housing, gear box and gear plate are all made from magnesium alloy for minimal weight and maximum strength. The all-metal construction allows for both improved cooling and increased durability. The smart electronic motor control includes soft start, current and thermal overload as well as a very useful load indicator light. The tough construction also extends to the three speed oil bath gear box, with mechanical clutch and integrated water feed system. The 60mm mounting neck can also mount into a rig for even larger drilling jobs. The two-in-one spindle offers both 1-1/4" UNC and 1/2" BSP and has a built-in anti-seize ring. For electrical safety we include the PRCD / GFCI interrupter. If you're a professional and you need the best of the best, then look no further.

■ Pistol-Handle Model (DM6P)

Magnesium Alloy construction for optimized cooling, durability and light weight



■ D-Handle Model (DM6D)

Magnesium Alloy construction for optimized cooling, durability and light weight

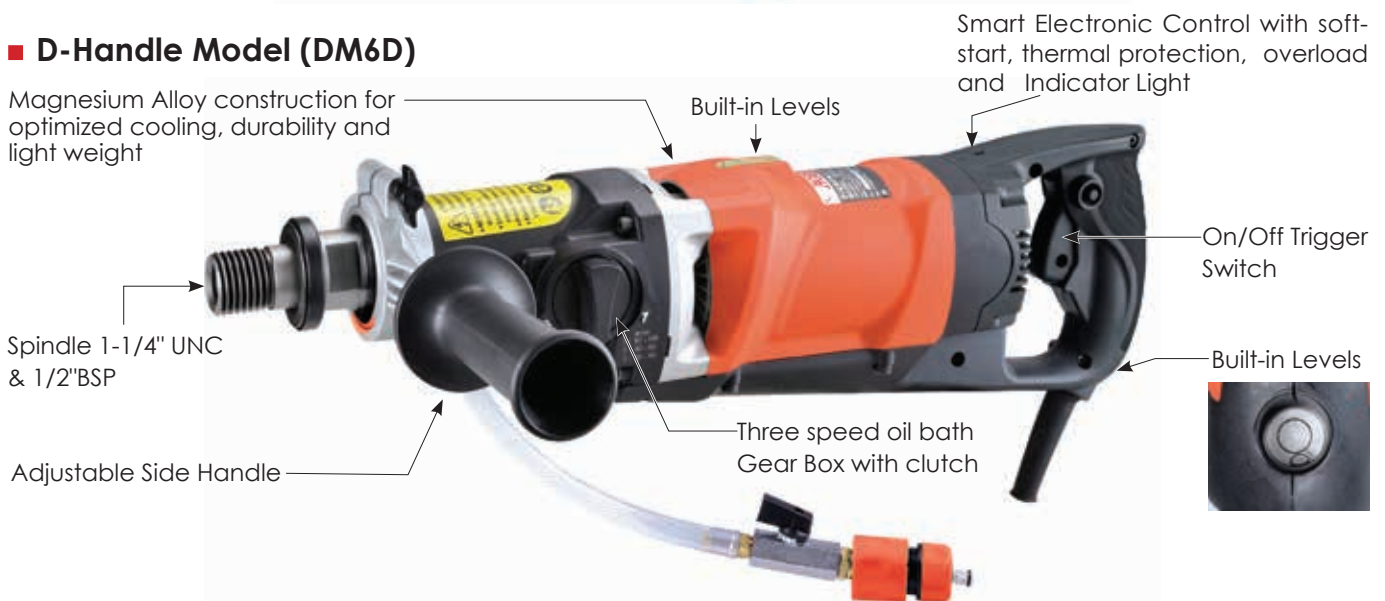

Model	DM6P	DM6D
Power Input	110-120V:1700W (15A), 220-240V:2000W (8.7A)	
Voltage	110-120V~ 50-60Hz, 220-240V~ 50-60Hz	
No Load min ⁻¹	930 / 1520 / 4270	
Rated Load Speeds min ⁻¹	560 / 910 / 2560	
Capacity	Hand-Held: 80mm (3") Rig-Mounted:160mm (6-1/4")	
Spindle Thread External / Internal	1-1/4" UNC / 1/2" BSP	
Neck Diameter	60mm	
Soft Start & Overload Protection	With	
Mechanical Safety Clutch	With	
Protection Class	Class I with PRCD / GFCI	
Dimensions(LxWxH)	437mm x 115mm x 289mm	528mm x 106mm x 145mm
Net Weight	6.3kg(13.89Lbs)	



STANDARD ACCESSORIES

- * Side Handle x1
- * Water Supply Kit x1
- * M32 Combination Wrench x2
- * PRCD / GFCI Interrupter x1

OPTIONAL ACCESSORIES

- * Anti-Vibration Side Handle x1
- * SDS Pilot Drill Socket x1

RIG-MOUNTED DIAMOND CORE DRILL MOTORS

Our all-new **DM10 & DM14** are the latest in our new premium line of diamond core drilling machines. These are built for the stresses of continuous professional use. The motors are built for extreme durability and super efficiency. These are our most powerful single phase motors. The all-metal construction allows for both improved cooling and increased durability. The relay type switch avoids accidental restarts. The smart electronic motor control includes soft start, current and thermal overload as well as a very useful pulse overload warning system. The oil bath four and three speed gear boxes include a high performance mechanical clutch. The spindle includes an anti-seize ring. If you're a professional and are looking for a serious core drilling motor, then this is the machine for you.

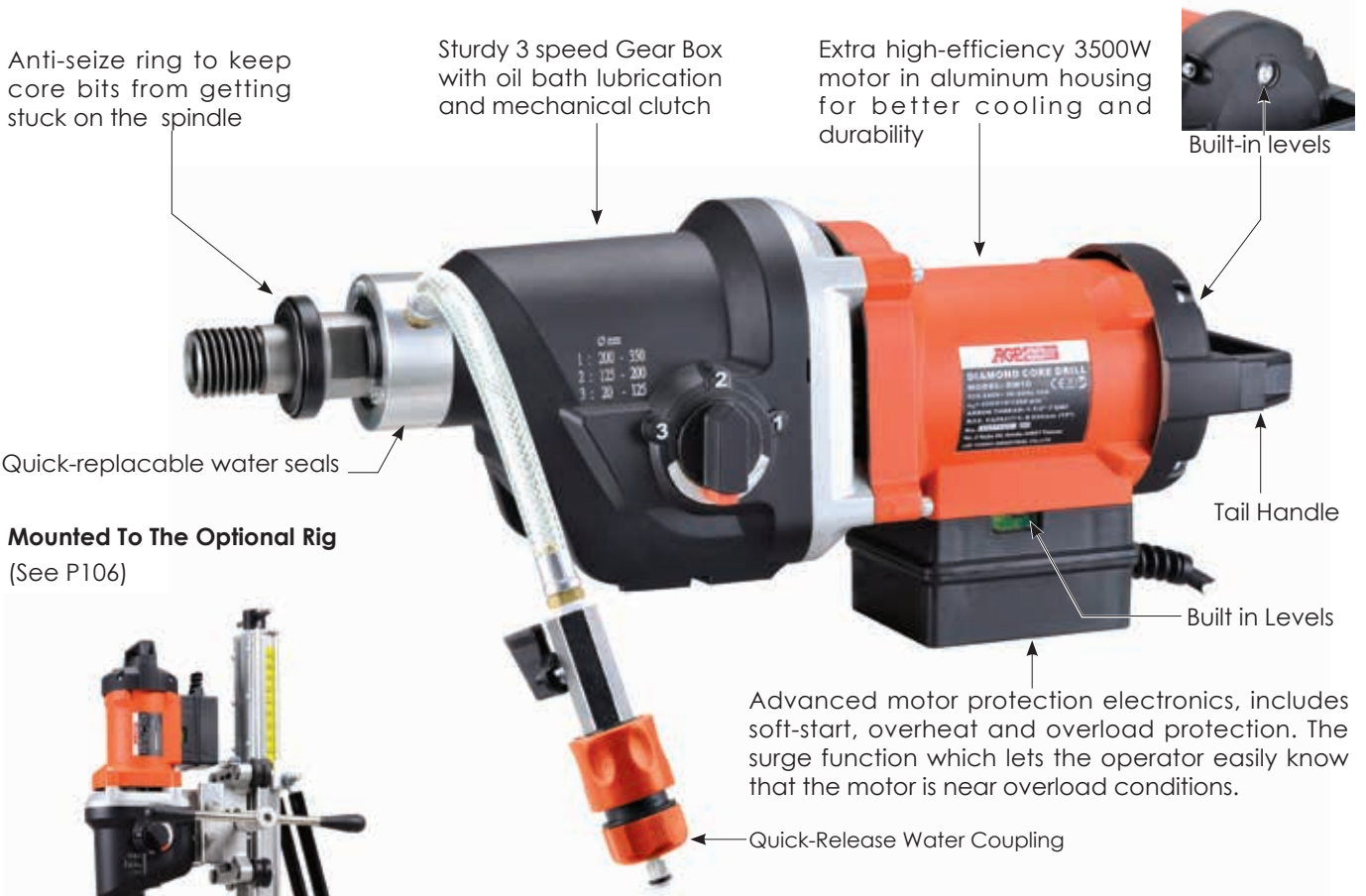

Mounted To The Optional Rig
(See P106)



Optional: 40mm spacer

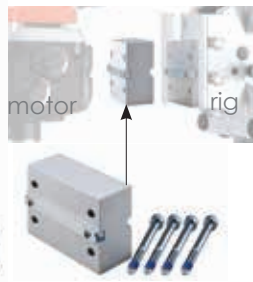

To provide clearance for the switch box when mounting the motor to some models of other manufacturers' rigs. (The spacer also adds an extra 80mm to the maximum core bit diameter with a given stand.)

Part Number
0299-0214-0000-001

40mm spacer



Model	DM10
Power Input	110-120V:2800W (25A), 220-240V:3500W (16A)
Voltage	110-120V~ 50-60Hz, 220-240V~ 50-60Hz
No Load Speeds min ⁻¹	450 / 810 / 1300
Rated Load Speeds min ⁻¹	270 / 480 / 780
Drilling Capacity	Ø350
Gear Oil Type	90W
Gear Oil Capacity	500ml
Spindle Thread	1-1/4" UNC male, 1/2" BSP female
Protection Class	Class I With PRCD / GFCI
Soft Start & Overload Protection	With
Dimensions(LxWxH)	550mm x 155mm x 210mm
Weight	12.9kg (28.4 Lbs)

STANDARD ACCESSORIES

- * Water Supply Kit x1
 - * PRCD / GFCI Interrupter x1
- REMARK:110-120V W/O PRCD / GFCI

OPTIONAL ACCESSORIES

- * 40mm spacer x1

RIG-MOUNTED DIAMOND CORE DRILL MOTORS

Anti-seize ring to keep core bits from getting stuck on the spindle

Sturdy 4 speed Gear Box with oil bath lubrication and mechanical clutch

Extra high-efficiency 3500W motor in aluminum housing for better cooling and durability

Tail Handle

Quick-replaceable water seals



Mounted To The Optional Rig
(See P 106)



Advanced motor protection electronics, includes soft-start, overheat and overload protection. The surge function which lets the operator easily know that the motor is near overload conditions.

Built in Levels

Quick-Release Water Coupling

Built-in levels



Optional: 40mm spacer

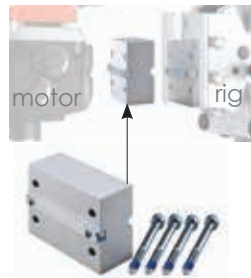

To provide clearance for the switch box when mounting the motor to some models of other manufacturers' rigs. (The spacer also adds an extra 80mm to the maximum core bit diameter with a given stand.)

40mm spacer

Part Number

0299-0214-0000-001



Model	DM14
Power Input	110-120V:2800W (25A), 220-240V:3500W (16A)
Voltage	110-120V~ 50-60Hz, 220-240V~ 50-60Hz
No Load Speeds min ⁻¹	385 / 530 / 975 / 1340
Rated Load Speeds min ⁻¹	225 / 300 / 565 / 780
Drilling Capacity	Ø450
Gear Oil Type	90W
Gear Oil Capacity	500ml
Spindle Thread	1-1/4" UNC male, 1/2" BSP female
Protection Class	Class I With PRCD / GFCI (110-120V W/O PRCD / GFCI)
Soft Start & Overload Protection	With
Dimensions(LxWxH)	550mm x 155mm x 210mm
Weight	13.5kg (27.8 Lbs)

STANDARD ACCESSORIES

- * Water Supply Kit x1
 - * PRCD / GFCI Interrupter x1
- REMARK:110-120V W/O PRCD / GFCI

OPTIONAL ACCESSORIES

- * 40mm spacer x1

DIAMOND CORE DRILL STANDS

Our premium line of drill stands were created to provide the capabilities required by high capacity operators who need a rig which can remain stable under the most extreme torque loads. The alloy mast with tilt capability and steel base give the most rigid structure possible with the roller carriage providing perfect guidance with zero play. For convenience, the crank handle doubles as a wrench for many of the fasteners and adjusters. The largest stand in the series is conservatively rated for 800mm (32") core bits. This is followed by the 500mm (20"), 250mm (10") and 170mm (6-1/2") versions. In addition to the standard 1:1 crank gearing, the 800mm and 500mm versions also include a second built-in crank spindle with reduction gearing of 4:1 and 3.3:1 respectively. This makes drilling in large sizes a lot easier on the operator. Optional extension spacers are available for larger diameter core bits to maintain clearance between the bit and the stand. Extension spacers in sizes 45, 100, 150 and 200mm are optionally available. These may also be stacked together as needed to achieve the required distance. In addition to the standard mounting spacer, the 250mm stand comes with a clamp bracket for mounting hand-held drilling motors. This part is available as an option for the other stands, as well. The 170mm stand is equipped with our unique quick-release cradle system. It has never been so quick and easy to mount and dismount the motor from the stand!

S800

S800 standard with 1m column. Also available with 2m column (1790mm stroke) or 2.5m column (2290mm stroke)

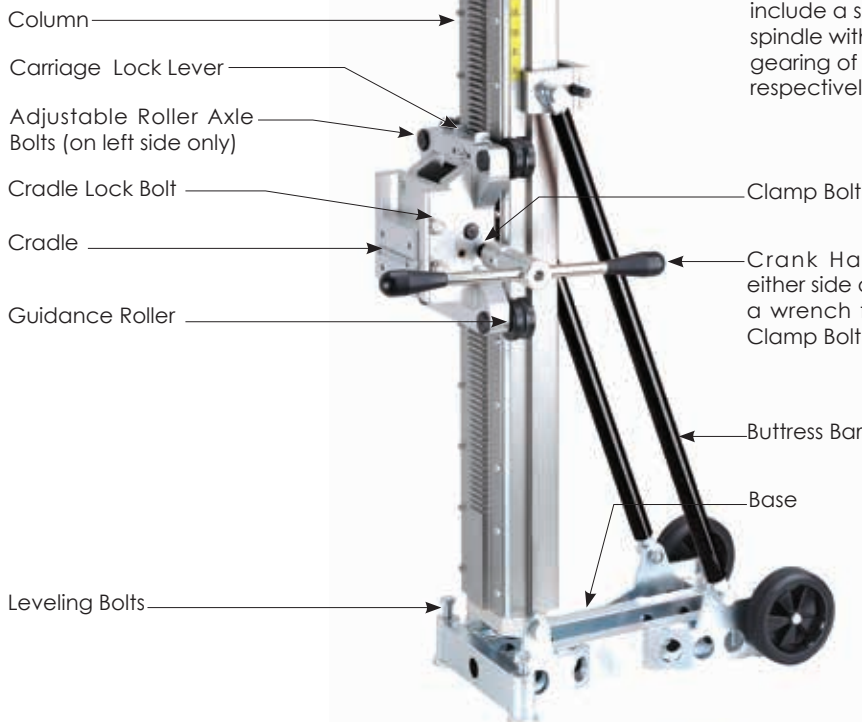

800mm and 500mm versions include a second crank spindle with reduction gearing of 4:1 and 3.3:1 respectively.



Mounting Spacer
Standard for S250, S500 & S800

Jack Screw (Optional)

Front Handle (Optional)



S170

Patented Quick-Release Cradle makes it super-easy to mount and dismount the motor from the stand



S250

S250 includes both 60mm clamp bracket and standard mounting spacer



S500

S500 standard with 900mm column. Also available with 1.6m column (1390mm stroke)



Optional Rigs for DM160

Built In Bubble Levels

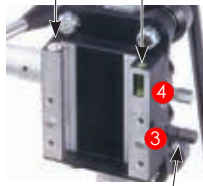

Locking Screw



Quick Setting Design

44mm Clamp Bracket



60mm Clamp Bracket

OS250

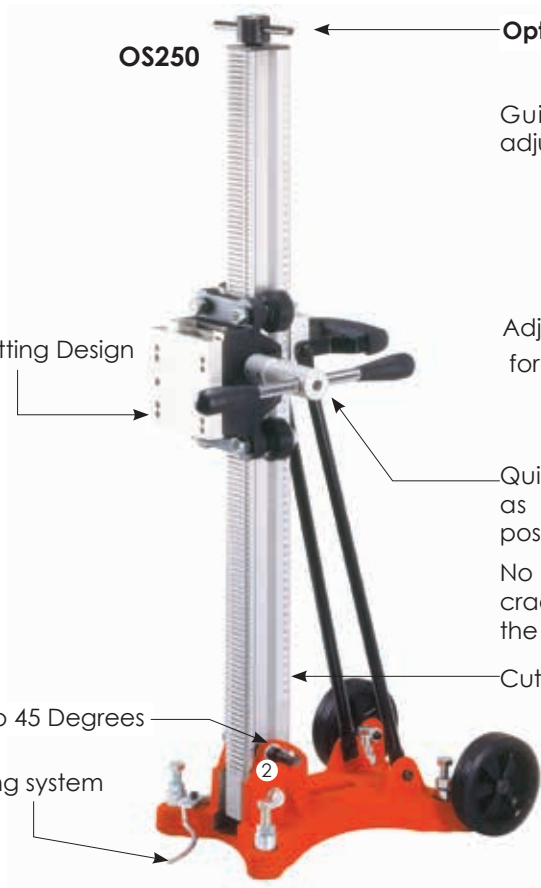

Optional : Jack Screw

Guide rollers on eccentric shafts for adjusting play in carriage guidance

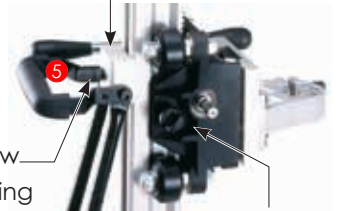

Adjusting screw for angle setting

Locking Knob

Quick release Crank handle can double as a Hex. Wrench to fit the following 5 positions ① ② ③ ④ ⑤

No extra wrench is needed to release the cradle, loosen the clamp bracket or adjust the tilt angle!

Cutting Depth Scale

Tilts Up To 45 Degrees

Centering system

Optional: Wheels

Dimensions

36 x 24 x 96cm

Application

All hand-held models

Neck Diameter

60mm
44mm

Choose either 44mm or 60mm Clamp Bracket when ordering

STANDARD ACCESSORIES

- * Crank Handle
- * M19 Combination Wrench
- * Mounting Spacer (except S170)
- * Quick-Release Clamp Bracket (S170 only)
- * OS250 only: 44mm or 60mm Clamp Bracket (Specify when ordering)

OPTIONAL ACCESSORIES

- * Jack Screw (except S170)
- * 60mm Clamp Bracket (except S170)
- * Wheels (OS250 only)



60mm clamp bracket for mounting hand-held drilling motors. Bolts directly to the standard mounting spacer (Fits all stand models except S170)

EXTENSION SPACERS (OPTIONAL)



200mm



150mm



100mm



45mm



Anchoring Plate

200mm
150mm
100mm
45mm
Anchoring Plate

Part Number

0299-0159-00000-004
0299-0159-00000-003
0299-0159-00000-002
0299-0159-00000-001
302-04464-903-001

Model	S170	S250	S500	S800	OS250
Capacity w/o extension spacers (mm)	Ø170	Ø250	Ø350	Ø350	Ø250
Max. Capacity with extension spacers (mm)	N/A	N/A	Ø500	Ø800	N/A
Effective Stroke(mm)	540	660	690	760	615
Dimensions (LxWxH)(mm)	330 x 200 x 815	390 x 248 x 970	425 x 245 x 1005	555 x 275 x 1035	360 x 240 x 960
Net Weight(Not Including crank handle)(kg)	8.8kg(19.4lbs)	13.5kg(29.76lbs)	18.0kg(39.68lbs)	26.5kg(58.42lbs)	13.5kg (29.76lbs)

PS: S800 available with 2m column (1790mm stroke) or 2.5m column (2290mm stroke)
S500 available with 1.6m column (1390mm stroke)

DIAMOND CORE BITS & OPTIONAL ACCESSORY SPECIFICATIONS



SDS Pilot Drill Socket



Jack Screw



PRCD / GFCI Interrupter protection



Dry Arbor Adaptor



Wet-Type Thread Adaptor



Front Handle Set

- **SDS Pilot Drill Socket (for models with female 1/2" BSP spindles) x1**

Part Numbers
302-04387-907-001

- **Jack Screw for S250, OS250, S500 x1**

302-04178-907-001

- **Jack Screw for S800 x1**

302-04178-907-003

- **Wet-Type Thread Adaptor (For models with 1-1/4"-7 UNC spindles) x1**

1-1/4"-7 UNC to 1-1/4"-3 Acme

302-04311-901-002

- **Dry Arbor Adaptor for models with 1-1/4"-7 UNC spindles x1**

(1-1/4"-7 UNC to M16-2.0 with MT1 Taper for Pilot Drill. Drift included).

302-04311-000-002

- **Front Handle Set for S500 x1**

0299-0211-0000-001

- **Vacuum Collector Pad**

This device adheres to the wall by vacuum cleaner suction and very effectively collects the dust or water right at the source. Various rings are available for different core sizes. Note: Not for overhead drilling.



Vacuum Collector Pad (small)



Ring Set



Vacuum Collector Pad (large)



Ring Set

Part Number

Vacuum Collector Pad Set (small)x1	0299-0113-00000-002
Vacuum Collector Pad (small) x1	303-02025-004-002
Ring (D45) x1	303-02034-004-003
Ring (D55) x1	303-02034-004-004
Ring (D65) x1	303-02034-004-005
Ring (D75) x1	303-02034-004-006

Part Number

Vacuum Collector Pad Set (large)x1	0299-0113-00000-001
Vacuum Collector Pad (large) x1	303-02025-004-001
Ring (D110) x1	303-02034-004-001
Ring (D130) x1	303-02034-004-002

- **Torque Wrench Adapter Socket x1**



Description:

Grips the clutch gear to test the actual slippage torque of the assembled clutch with a dial indicator torque gauge. (1/4" square drive connection)

Part Number

DM5:	302-04480-903-001
DM6:	302-04480-903-003
DM10 & DM14:	302-04480-903-005

- **Holding Fixture for adjusting clutches x1**

Description:

When mounted in a bench vise, holds the clutch gear without damaging the gear teeth while tightening the clutch nut and testing torque.



Part Number

DM5:	202-0117-00000-001
DM6:	0202-0117-00000-002
DM10:	0202-0117-00000-003
DM14:	0202-0117-00000-004

- **Anti-Vibration Side Handle** for DM52P, DM52D, DM51P, DM51D, DMC6P,DMC6D,DM6P, DM6D, DM160 x1



Part Numbers

203-0115-00004-001

■ 1-Piece Wet-Type Diamond Core Bits (For models with 1-1/4"-7 UNC spindles)

These are excellent, general-purpose wet core bits which are long wearing. They are especially good for heavily reinforced concrete with hard aggregates.



**450mm Length
(1-1/4"-7 UNC Coupling)
Diameter (mm)**

**Segment Dimensions (mm)
Height x Thickness &
Number of Segments**

Part Number

25	H 9 x T 3.2 - single seg.	305-03356-004-034
32	H 9 x T 3.2 - single seg.	305-03356-004-035
38	H 9 x T 3.2 - single seg.	305-03356-004-036
42	H 9 x T 3.2 - single seg.	305-03356-004-037
52	H 10 x T 3.5 - 5 seg.	305-03356-004-038
56	H 10 x T 3.5 - 5 seg.	305-03356-004-039
62	H 10 x T 3.5 - 5 seg.	305-03356-004-040
65	H 10 x T 3.5 - 6 seg.	305-03356-004-041
72	H 10 x T 3.5 - 6 seg.	305-03356-004-042
76	H 10 x T 3.5 - 7 seg.	305-03356-004-043
82	H 10 x T 3.5 - 7 seg.	305-03356-004-044
86	H 10 x T 3.5 - 7 seg.	305-03356-004-045
92	H 10 x T 3.5 - 8 seg.	305-03356-004-046
102	H 10 x T 3.5 - 9 seg.	305-03356-004-047
111	H 10 x T 3.5 - 10 seg.	305-03356-004-048
113	H 10 x T 3.5 - 10 seg.	305-03356-004-049
121	H 10 x T 3.5 - 10 seg.	305-03356-004-050
127	H 10 x T 3.5 - 10 seg.	305-03356-004-051
131	H 10 x T 3.5 - 10 seg.	305-03356-004-052
141	H 10 x T 3.5 - 11 seg.	305-03356-004-053
152	H 10 x T 4.0 - 12 seg.	305-03356-004-054
162	H 10 x T 4.0 - 12 seg.	305-03356-004-055
172	H 10 x T 4.0 - 13 seg.	305-03356-004-056
182	H 10 x T 4.0 - 13 seg.	305-03356-004-057
200	H 10 x T 4.0 - 14 seg.	305-03356-004-058
205	H 10 x T 4.0 - 14 seg.	305-03356-004-059
226	H 10 x T 4.5 - 15 seg.	305-03356-004-060
232	H 10 x T 4.5 - 16 seg.	305-03356-004-061
252	H 10 x T 4.5 - 16 seg.	305-03356-004-062
300	H 10 x T 5.0 - 20 seg.	305-03356-004-063
305	H 10 x T 5.0 - 20 seg.	305-03356-004-064
332	H 10 x T 5.0 - 22 seg.	305-03356-004-065
356	H 10 x T 5.0 - 24 seg.	305-03356-004-066

Special Core Bit for Asphalt:

102	H 10 x T 4.0 - 9 seg.	305-03356-004-067
-----	-----------------------	-------------------

■ Dry-Type Diamond Core Bits (For models with M16 coupling)

Excellent dry drilling performance. Spiral tube with side holes. Turbo segments for hard construction materials.



Diameter (mm)	Part Number	Part Number
	150mm Length	250mm Length
32	305-03356-004-068	305-03356-004-108
38	305-03356-004-069	305-03356-004-109
42	305-03356-004-070	305-03356-004-110
52	305-03356-004-071	305-03356-004-111
62	305-03356-004-072	305-03356-004-112
65	305-03356-004-073	305-03356-004-113
72	305-03356-004-074	305-03356-004-114
78	305-03356-004-075	305-03356-004-115
82	305-03356-004-076	305-03356-004-116
86	305-03356-004-077	305-03356-004-078

■ Tile Diamond Core Bits (For models-TC20, TC40, TC402, TC100)

Dry or Wet drilling of extremely hard tile, granite & marble slabs. Length: 66mm



Diameter (mm)	Part Number	Part Number
	M14-2.0 Thread	G 1/2" BSP Thread
6	305-03356-004-084	305-03356-004-096
8	305-03356-004-085	305-03356-004-097
10	305-03356-004-086	305-03356-004-098
12	305-03356-004-087	305-03356-004-099
14	305-03356-004-088	305-03356-004-100
16	305-03356-004-089	305-03356-004-101
18	305-03356-004-090	305-03356-004-102
20	305-03356-004-091	305-03356-004-103
25	305-03356-004-092	305-03356-004-104
30	305-03356-004-093	305-03356-004-105
35	305-03356-004-094	305-03356-004-106
40	305-03356-004-095	305-03356-004-107

Electric Screw Driver



Model	LY0855
Power Input	500 W
Voltage	110-120V~ 50-60Hz, 220-240V~ 50-60Hz
No Load min ⁻¹	0-2500
Capacity	6mm (1/4")
Dimensions (LxWxH)	275mm x 70mm x 180mm
Net Weight	1.5kg (3.31 Lbs)

STANDARD ACCESSORIES

- * Magnetic socket 5/16" x1

Wood Trimmer



Model	LY0608N
Power Input	440 W
Voltage	110-120V~ 50-60Hz, 220-240V~ 50-60Hz
No Load min ⁻¹	30,000
Capacities	6mm or 6.35mm (1/4")
Dimensions(LxWxH)	245mm x 85mm x 115mm
Net Weight	1.27kg (2.8 Lbs)

STANDARD ACCESSORIES

- * Straight Guide Assy x1
- * Arbor wrench M13/M22 x2

Flexible Shaft Grinder



Model	LY128
Power Input	550 W
Voltage	110-120V~ 50-60Hz, 220-240V~ 50-60Hz
No Load min ⁻¹	0~16,000
Capacity	3mm (1/8")
Dimensions(LxWxH)(Motor unit only)	95mm x 95mm x 140mm
Net Weight	2.3kg (5.07 Lbs)

STANDARD ACCESSORIES

- * Complete Drive Shaft Set (W/O Bit) x1

Impact Wrench



Model	LY1726
Power Input	500 W
Voltage	110-120V~ 50-60Hz, 220-240V~ 50-60Hz
No Load min ⁻¹	0~2100
Square Drive W/P	1/2 in.
Impact Per Minute	0~2800
Max. Torque	150 N-m
Dimensions(LxWxH)	280mm x 70mm x 180mm
Net Weight	1.7kg (3.75 Lbs)

STANDARD ACCESSORIES

- * Socket 21mm x1
- * Socket 19mm x1

GEAR MACHINING & ELECTRONICS BOARDS

We at AGP are proud of our gear machining and PC board department and welcome inquiries for a CM (contract manufacturer) basis.

We have long experience with both ODM and OEM manufacturing.

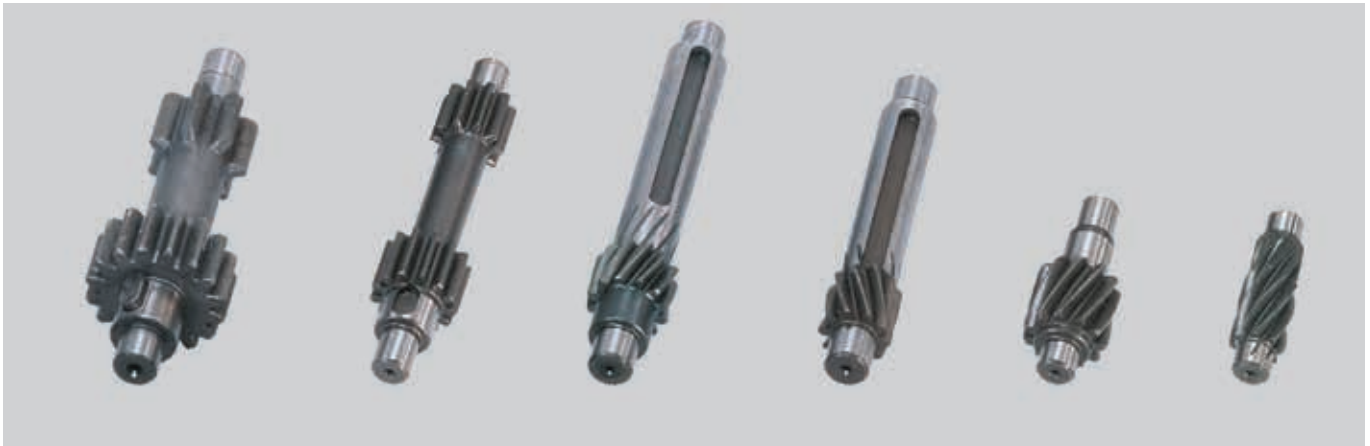

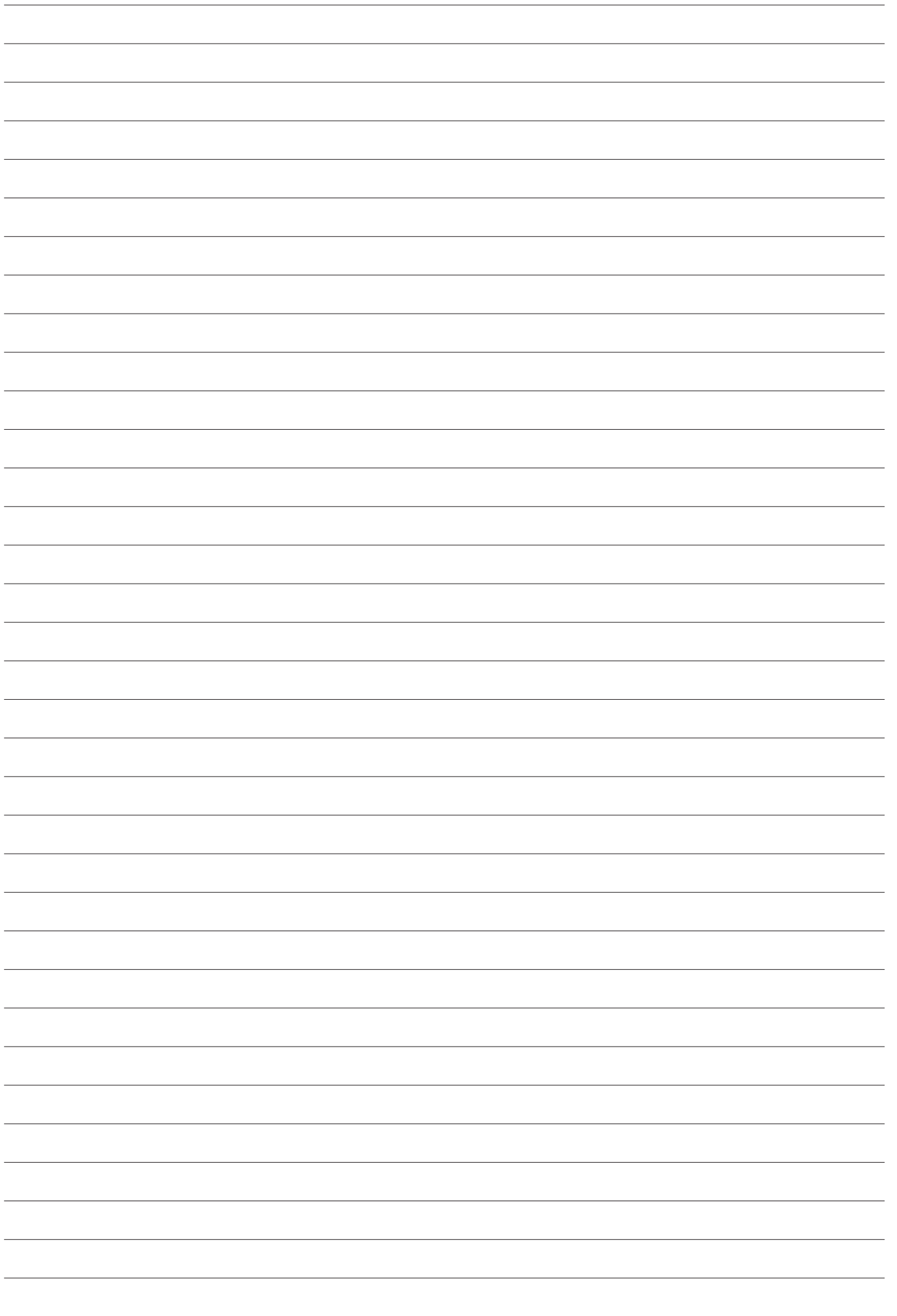

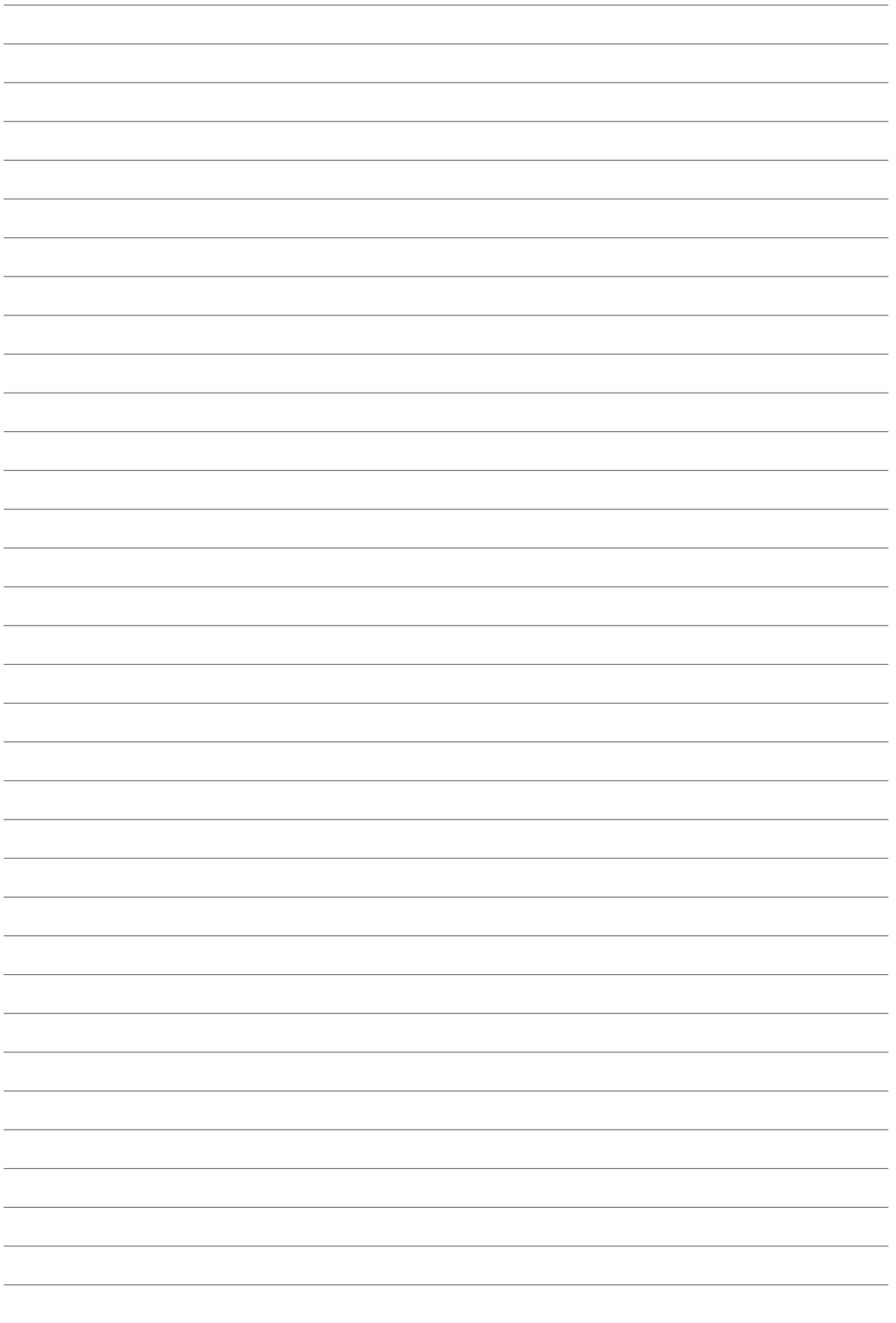

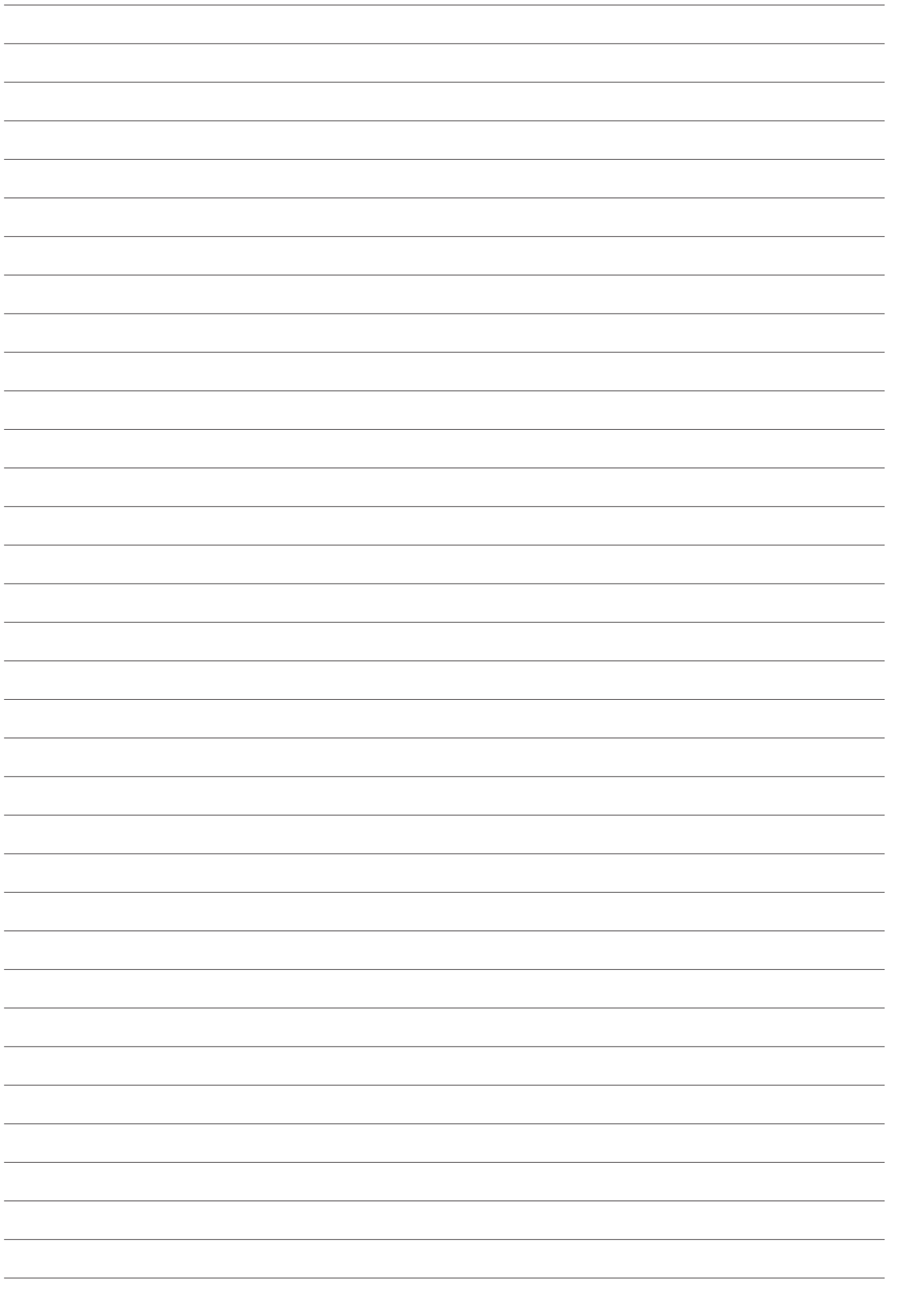



LEE YEONG INDUSTRIAL CO., LTD.

No.2, Kejia Rd., Douliu City, Yunlin County
64057, Taiwan

Tel: 886-5-5518689 Fax: 886-5-5518635

<http://www.agp-powertools.com>

Youtube: [https://www.youtube.com/
channel/UCeLEcS0HFgDq6ec2FIGXm5g](https://www.youtube.com/channel/UCeLEcS0HFgDq6ec2FIGXm5g)

E-mail: sale@agp-powertools.com

E-mail: diane@agp-powertools.com

AGP[®]